

Rope Pull Emergency Stop Switch

ER1032

- Long rope spans up to 200 m makes this switch ideal for applications where long rope spans are required
- Heavy-duty housing—the die-cast housing and stainless steel eye nut make the ER1032 suitable for demanding industrial applications
- IP67 (NEMA 6) enclosure enables the ER1032 switch to withstand water washdown cleaning
- Integral E-stop—the E-stop button provides emergency stopping capability at the extreme end of the installation and is field serviceable
- Tension indicator—the tension indicator makes the system easy to set up and to maintain the proper rope tension
- 4 N/C safety contacts and 2 N/O auxiliary contacts satisfy the most demanding applications
- Vibration tolerant—the snap-acting switch contacts protect against nuisance tripping due to vibration
- Long life—the ER1032 switch is designed for a minimum of one million actuations
- Indicator beacon—the indicator beacon, available in 24 VDC can be wired to flash red to indicate a tripped switch or glow a constant green to indicate a properly reset switch



Operation

Blue Reset Button



A blue reset button is provided to easily return the unit back to its machine-run position after actuation.

Installation Hardware Available

RK Rope Tension Kit



The RK Rope Tension Kit comes with all of the required hardware for most installations. A spring is required as shown in the installation example below.

Installation Hardware

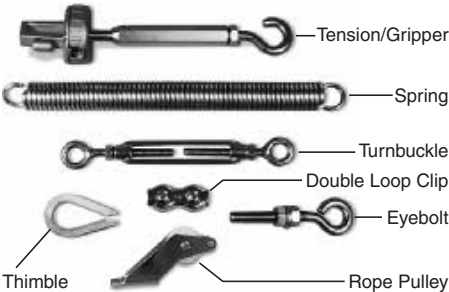

Individual hardware items may be purchased for specific installation requirements.

Contact Arrangements

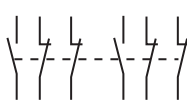

	0 mm	4.0 mm	15.0 mm	17.0 mm
4NC + 2NO	Rope Slack	Tension Range		Rope Pulled
11/12				
21/22				
33/34				
41/42				
51/52				
63/64				

□ Contact Open ■ Contact Closed

Mounting Specification

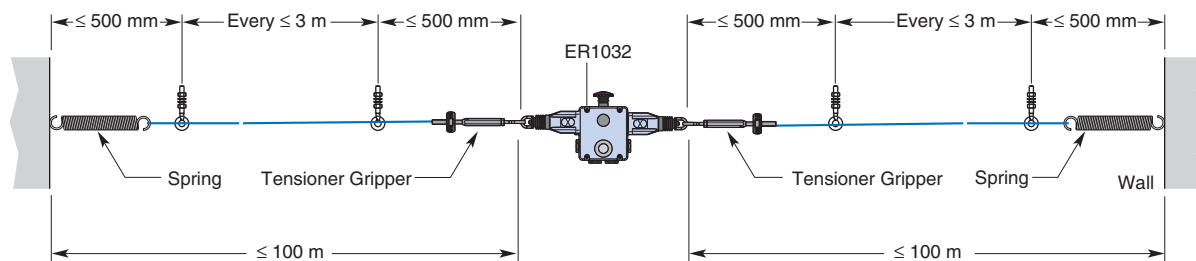
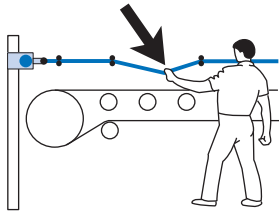

Note: Some installations may require a ER1022 on each end.

Applications

Typical applications are on conveyor systems and across rotating machinery, and around hazardous areas.

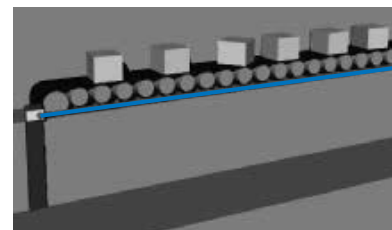
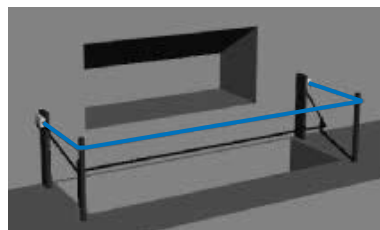

Ordering information

Rope Pull Emergency Stop Switch

E-Stop	Indicator Beacon	Contacts	Wiring Entry	Model
Included	Included (24 VDC)	4 N/C + 2 N/O	4 x M20	44506-7410 ER1032-042MEL

Accessories

Item	Model
Replacement Lid/LED, 24 VDC	44506-7710 SM06-SL711
Replacement LED indicator beacon, 24 VDC	44506-4740 SM06-LF40
Yellow E-Stop Background label	44506-4791 SM06-YLES
Rope Kit, 5 m, Stainless Steel	44506-2705 RK5
Rope Kit, 10 m, Stainless Steel	44506-2710 RK10
Rope Kit, 20 m, Stainless Steel	44506-2720 RK20
Rope Kit, 50 m, Stainless Steel	44506-2750 RK50
Rope Kit, 80 m, Stainless Steel	44506-2780 RK80
Rope Kit, 100 m, Stainless Steel	44506-2711 RK100
Rope Kit, 126 m, Stainless Steel	44506-2726 RK126
Rope Only, 5 m	44506-3705 R5M
Rope Only, 10 m	44506-3710 R10M
Rope Only, 20 m	44506-3720 R20M
Rope Only, 50 m	44506-3750 R50M
Rope Only, 100 m	44506-3711 R100M
Rope Only, 126 m	44506-3726 R126M

Item	Model
Tensioner Gripper, Stainless Steel	44506-4700 SM06-TG00
Eye Bolt Stainless Steel, 8 per pack	44506-4710 SM06-EB10
Double Loop Clip, Stainless Steel, 4 per pack	44506-4720 SM06-DL20
Thimble Stainless Steel, 4 per pack	44506-4770 SM06-THSS
Turnbuckle, Stainless Steel	44506-4730 SM06-TB30
Spring, Stainless Steel	44506-4750 SM06-SP50
Rope Pulley, Stainless Steel	44506-4780 SM06-RPSS
E-Stop Mechanism	44506-4760 SM06-ES60

Specifications

Electrical	Contact Configurations	4 N/C + 2 N/O
	Safety Contacts	4 N/C
	Switching Ability	AC: 240 V–3 A, 120 V–6 A, Inductive DC: 24 V–2.5 A, Inductive
	Contact material	Silver
	Terminals	up to 2,5 mm ² conductors
	Auxiliary Contacts	2 N/O
	Max Switching Current/Volt/Amp	240 V/720 VA
	Minimum Current	5 V, 5 mA DC
	Electrical Life	1,000,000 minimum
	LED Indicator Beacon	24 VDC
Mechanical	Mounting	Any position
	Mounting Hardware	4 x M5 screws
	Actuator Travel for Positive Opening	See diagrams on previous page
	Max Rope Span	125 m
	Operation Force	< 125 N
	Tensioning Force to Run Position	130 N
	Case Material	Die-cast aluminum alloy
	Eye Nut Material	Stainless steel
	Wiring Entry	4 x M20
	Weight	1320 g
	Color	Yellow
Environmental	Protection	IP67 (NEMA 6)
Environmental	Operating Temperature	-25 to 80°C
	Cleaning	Water washdown
Compliance	Standards	EN60947-5-1:2004, EN60947-5-5:1997+A1:2005; EN60204-1; EN ISO 13850:2006
	Approvals/Listings	CE marked for all applicable directives, UL and C-UL

Note: The safety contacts of the Omron STI switches are described as normally closed (N/C)—i.e., with the rope properly tensioned and the machine able to be started.

Dimensions

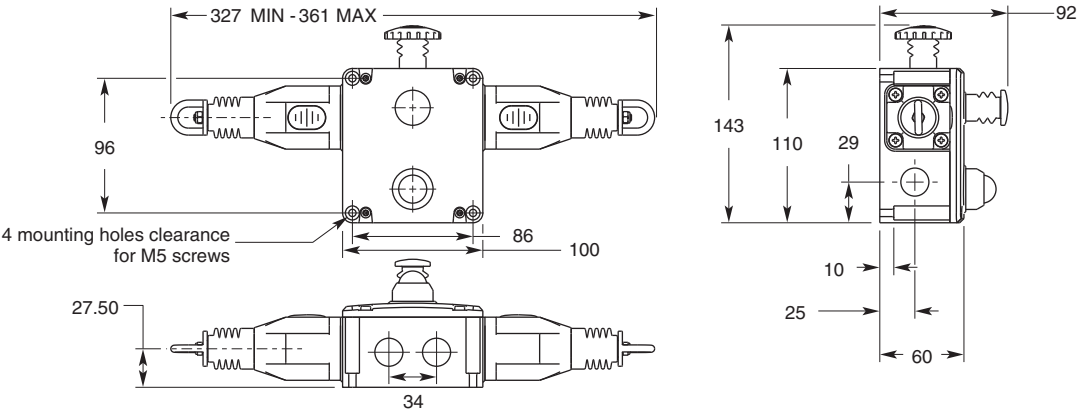

Safety precautions

Operating instructions

Installation must be in accordance with the following steps and stated specifications and should be carried out by suitably competent personnel. Adherence to the recommended maintenance instructions forms part of the warranty.

WARNING Do not defeat, tamper, remove or bypass this unit. Severe injury to personnel could result.

Optional 24 VDC Indicator Beacon

When +24VDC is applied to the **red** wire, the beacon will illuminate red and flash.

When +24 VDC is applied to the **green** wire, the beacon will illuminate green.

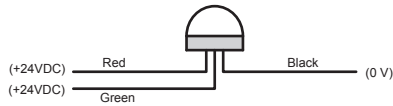

Tension Indicator

Indicator shown with steel rope properly adjusted.

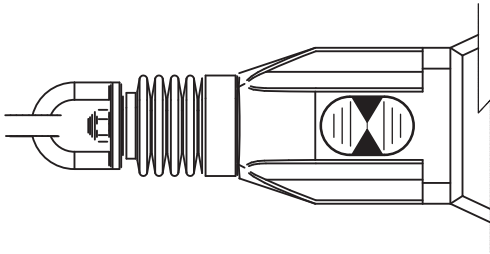

WARNING

1. Installation of all Safety Rope Switch systems must be in accordance with a risk assessment for the individual application. Installation must only be carried out by competent personnel and in accordance with these instructions.
2. Rope support eyebolts must be fitted at 2.5 m. min. to 3 m. max. intervals along all rope lengths between switches. The rope must be supported no more than 500 mm from the switch eyebolt or Safety Spring (if used). It is important that this first 500 mm is not used as part of the active protection coverage.
3. M5 mounting bolts must be used to fix the switches. Tightening torque for mounting bolts to ensure reliable fixing is 4 Nm. Tightening torque for the lid screws, conduit entry plugs and cable glands must be 1.5 Nm to ensure IP seal. Only use correct sizing glands for conduit entry and cable outside diameter.
4. Tensioning of rope is achieved by use of tensioner / gripper assemblies. Upon installation, tension to mid-position as indicated by the red arrows in the viewing window of each switch. Check operation for all switches and the control circuits by pulling the rope at various locations along the active protection area and resetting each switch by depressing the Blue Reset button. Ensure each time that the switches latch off and require manual resetting by depressing the Blue Reset button. Increase the system tension further, if required, depending upon the checks along the active length of coverage. If fitted with a Mushroom type E-Stop button (Red) then test and reset each switch to ensure function of control circuits. Typical operational conditions for successful operation of system is less than 75 N. pulling force and less than 150 mm deflection of rope between eyebolt supports. If the optional LED is fitted but is not used, ensure that the conductors remain coiled and tied to the tie hole in the LED flange.
5. Every week: Check correct operation of system at locations along all coverage length. Check for nominal tension setting, re-tension rope if necessary. Every 6 months: Isolate power and remove cover. Check screw terminal tightness and check for signs of moisture ingress. Never attempt to repair any switch.

ALL DIMENSIONS SHOWN ARE IN MILLIMETERS.

To convert millimeters into inches, multiply by 0.03937. To convert grams into ounces, multiply by 0.03527.

