

## Low Profile Relays with Low Power Consumption



- Relays with forcibly guided contacts (EN50205 Class A, certified by VDE).
- Low profile - only 14.5 mm.
- Coil power consumption is 360 mW for 4 pole model or 500 mW for 6 pole model.
- Four-pole and six-pole Relays are available.
- The Relay's terminal arrangement simplifies PWB pattern design.
- Reinforced insulation.



⚠ Be sure to read the "Safety Precautions" on page 4 and the "Precautions for All Relays with Forcibly Guided Contacts".

## Model Number Structure

### Model Number Legend

G7SB- A B  
1      2

**1. NO Contact Poles**

- 2: DPST-NO
- 3: 3PST-NO
- 4: 4PST-NO
- 5: 5PST-NO

**2. NC Contact Poles**

- 1: SPST-NC
- 2: DPST-NC

## Ordering Information

### Relays with Forcibly Guided Contacts

Type	Sealing	Poles	Contact configuration	Rated voltage *	Model
Standard	Flux-tight	4 poles	3PST-NO, SPST-NC	24 VDC	<b>G7SB-3A1B</b>
			DPST-NO, DPST-NC		<b>G7SB-2A2B</b>
		6 poles	5PST-NO, SPST-NC		<b>G7SB-5A1B</b>
			4PST-NO, DPST-NC		<b>G7SB-4A2B</b>

\* Consult your OMRON representative for details on rated voltages of 12 VDC, 18 VDC and 21 VDC.

## Specifications

### Ratings

#### Coil

Rated voltage	Item	Rated current (mA)	Coil resistance ( $\Omega$ )	Must operate voltage (V)	Must release voltage (V)	Max. voltage (V)	Power consumption (mW)
24 VDC		4 poles: 15 6 poles: 20.8	4 poles: 1,600 6 poles: 1,152	75% max.	10% min.	110%	4 poles: Approx. 360 6 poles: Approx. 500

- Note:**
1. The rated current and coil resistance are measured at a coil temperature of 23°C with tolerances of  $\pm 15\%$ .
  2. Performance characteristics are based on a coil temperature of 23°C.
  3. The value given for the maximum voltage is for voltages applied Instantaneously to the Relay coil (at an ambient temperature of 23°C) and not continuously.

#### Contacts

Item	Load	Resistive load
Rated load		6 A at 250 VAC, 6 A at 30 VDC
Rated carry current		6 A
Max. switching voltage		250 VAC, 125 VDC
Max. switching current		6 A

### Characteristics

Contact resistance *1		100 m $\Omega$ max.
Operating time *2		20 ms max.
Response time *3		10 ms max.
Release time *2		20 ms max.
Maximum operating frequency	Mechanical	36,000 operations/h
	Rated load	1,800 operations/h
Insulation resistance *4		1,000 M $\Omega$ min. (at 500 VDC)
Dielectric strength *5		Between coil contacts/different poles: 3,000 VAC, 50/60 Hz for 1 min. Between poles 1–2, 2–3, and 3–4: 3,000 VAC, 50/60 Hz for 1 min. Between poles 4–5 and 5–6 (in 6-pole relays): 2,500 VAC, 50/60 Hz for 1 min. Between contacts of same polarity: 1,500 VAC, 50/60 Hz for 1 min.
Vibration resistance		10 to 55 Hz, 0.75-mm single amplitude (1.5-mm double amplitude)
Shock resistance	Destruction	1,000 m/s <sup>2</sup>
	Malfunction	100 m/s <sup>2</sup>
Durability *6	Mechanical	10,000,000 operations min. (at approx. 36,000 operations/h)
	Electrical	100,000 operations min. (at the rated load and approx. 1,800 operations/h)
Failure rate (P level) (reference value *7)		5 VDC, 1 mA
Ambient operating temperature *8		–40 to 85°C (with no icing or condensation)
Ambient operating humidity		5% to 85%
Weight		4 poles: Approx. 25 g 6 poles: Approx. 29 g

**Note:** The above values are initial values.

\*1. The contact resistance was measured with 1 A at 5 VDC using the voltage-drop method.

\*2. These times were measured at the rated voltage and an ambient temperature of 23°C. Contact bounce time is not included.

\*3. The response time is the time it takes for the normally open contacts to open after the coil voltage is turned OFF. Contact bounce time is included. Measurement conditions: Rated voltage operation, Ambient temperature: 23°C

\*4. The insulation resistance was measured with a 500-VDC megohmmeter at the same locations as the dielectric strength was measured.

\*5. Pole 3 refers to terminals 33–34, pole 4 refers to terminals 43–44, pole 5 refers to terminals 53–54, and pole 6 refers to terminals 63–64.

\*6. The durability is for an ambient temperature of 15 to 35°C and an ambient humidity of 25% to 75%.

\*7. The failure rate is based on an operating frequency of 300 operations/min.

\*8. When operating at a temperature between 70 and 85°C, reduce the rated carry current (6 A at 70°C or less) by 0.1 A for each degree above 70°C.

# Dimensions

## Relays with Forcibly Guided Contacts

G7SB-3A1B  
G7SB-2A2B

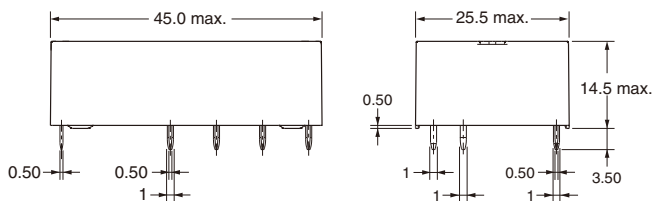
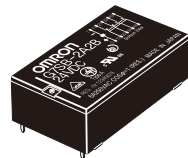

**Printed Circuit Board Design Diagram (Bottom View)**  
(±0.1 tolerance)

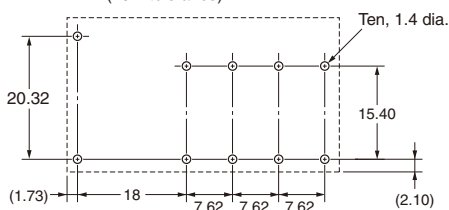

**Terminal Arrangement/ Internal Connection Diagram (Bottom View)**

G7SB-3A1B

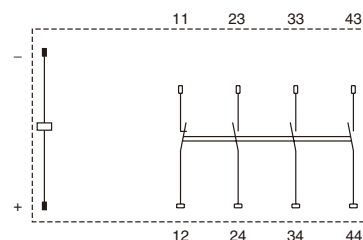

G7SA-2A2B

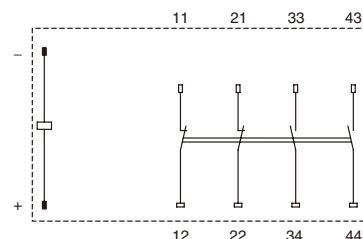

**Note:** Terminals 23-24, 33-34, and 43-44 are normally open. Terminals 11-12 and 21-22 are normally closed.

G7SB-5A1B  
G7SB-4A2B

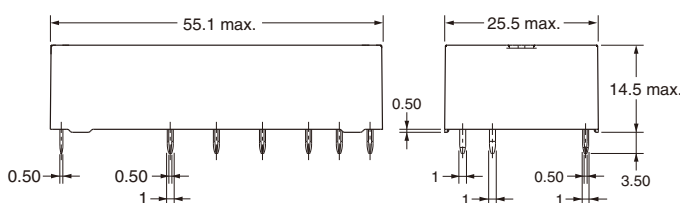
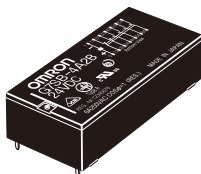

**Printed Circuit Board Design Diagram (Bottom View)**  
(±0.1 tolerance)

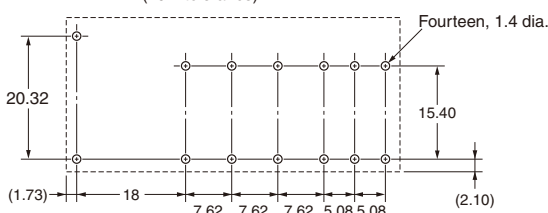

**Terminal Arrangement/ Internal Connection Diagram (Bottom View)**

G7SB-5A1B

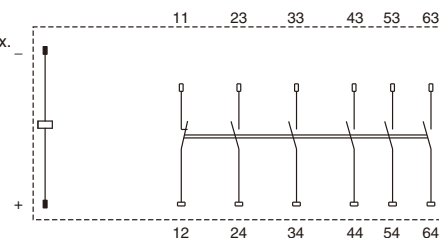

G7SA-4A2B

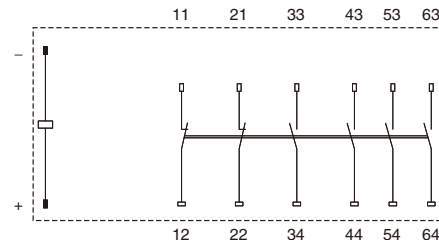

**Note:** Terminals 23-24, 33-34, 43-44, 53-54, and 63-64 are normally open. Terminals 11-12 and 21-22 are normally closed.

## Certified Standards

- G7SB
  - EN Standards, VDE Certified
    - EN61810-1 (Electromechanical non-specified time all-or-nothing relays)
    - EN50205 (Relays with forcibly guided (linked) contacts)
  - UL standard UL508 Industrial Control Devices
  - CSA standard CSA C22.2 No. 14 Industrial Control Devices

## Forcibly Guided Contacts (from EN50205)

If an NO contact becomes welded, all NC contacts will maintain a minimum distance of 0.5 mm when the coil is not energized. Likewise if an NC contact becomes welded, all NO contacts will maintain a minimum distance of 0.5 mm when the coil is energized.

## Safety Precautions

Refer to the “*Precautions for All Relays*” and “*Precautions for All Relays with Forcibly Guided Contacts*”.

### Precautions for Safe Use

#### Connections

The coil terminals have polarity (+/-). Operation will not be possible if the polarity is reversed.

#### Washing

The G7SB does not have a sealed structure. Do not wash G7SB Relays.

### Precautions for Correct Use

#### Mounting

The Relays with Forcibly Guided Contacts can be mounted in any direction.

#### Relays with Forcibly Guided Contacts

While the Relay with Forcibly Guided Contacts has the previously described forcibly guided contact structure, it is basically the same as an ordinary relay in other respects. Rather than serving to prevent malfunctions, the forcibly guided contact structure enables another circuit to detect the condition following a contact weld or other malfunction. Accordingly, when a contact weld occurs in a Relay with Forcibly Guided Contacts, depending on the circuit configuration, the power may not be interrupted, leaving the Relay in a potentially dangerous condition (as shown in Fig. 1.)

To configure the power control circuit to interrupt the power when a contact weld or other malfunction occurs, and to prevent restarting until the problem has been eliminated, add another Relay with Forcibly Guided Contacts or similar Relay in combination to provide redundancy and a self-monitoring function to the circuit (as shown in Fig. 2). Refer to the *Safety Components Technical Guide* (Cat No. Y107). The G9S/G9SA/G9SB Safety Relay Unit, which combines Relays such as the Relay with Forcibly Guided Contacts in order to provide the above-described functions, is available for this purpose. By connecting a contactor with appropriate input and output to the Safety Relay Unit, the circuit can be equipped with redundancy and a self-monitoring function.

Fig 1

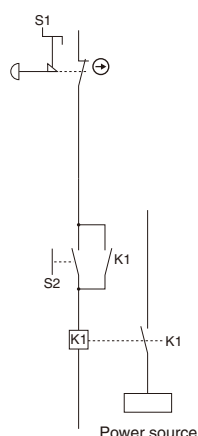
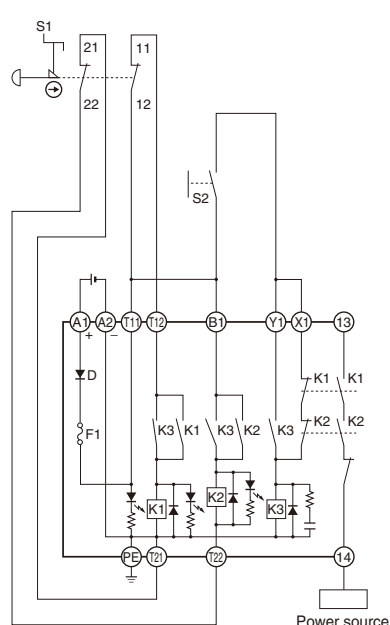

Fig 2



#### Durability of Contact Outputs

The durability of the Relays with Forcibly Guided Contacts varies considerably depending on switching conditions. Always confirm the usage conditions by testing the Relay with Forcibly Guided Contacts in an actual application, and use the Relay with Forcibly Guided Contacts only for the number of switching operations that its performance allows.

Restarting a safety circuit like the one incorporating the Relay with Forcibly Guided Contacts in Fig. 2 may not be possible if the switching capacity is exceeded. If this occurs, replace the relevant relays immediately. If a Relay with Forcibly Guided Contacts is used after performance has deteriorated, it may result in reduced safety.

#### CE Marking

(Source: *Guidelines on the Application of Council Directive 73/23/EEC*)

The G7SB has been recognized by the VDE for meeting the Low Voltage Directive according to EN requirements for relays and relays with forcibly guided contacts. The Low Voltage Directive, however, contains no clauses that specify handling methods for components, and interpretations vary among test sites and manufacturers. To solve this problem, the European Commission has created guidelines for the application of the Low Voltage Directive in EU. These guidelines present concepts for applying the Low Voltage Directive to components.

The G7SB, however, does not display the CE Marking according to the concepts in the guidelines.

VDE recognition, however, has been obtained, so there should be no problems in obtaining the CE Marking for machines that use the G7SB.

Use the manufacturer's compliance declaration to prove standard conformance.

#### Contents of the Guidelines

The *Guidelines on the Application of Council Directive 73/23/EEC* apply to components. Relays with PWB terminals are not covered by the Low Voltage Directive.

# Precautions for All Relays with Forcibly Guided Contacts

Refer to the “*Safety Precautions*” section for each Relay for specific precautions applicable to each Relay.

## Precautions for Correct Use

### Mounting

The Relays with Forcibly Guided Contacts can be mounted in any direction.

### Relays with Forcibly Guided Contacts

While the Relay with Forcibly Guided Contacts has the previously described forcibly guided contact structure, it is basically the same as an ordinary relay in other respects. Rather than serving to prevent malfunctions, the forcibly guided contact structure enables another circuit to detect the condition following a contact weld or other malfunction. Accordingly, when a contact weld occurs in a Relay with Forcibly Guided Contacts, depending on the circuit configuration, the power may not be interrupted, leaving the Relay in a potentially dangerous condition (as shown in Fig. 1.)

To configure the power control circuit to interrupt the power when a contact weld or other malfunction occurs, and to prevent restarting until the problem has been eliminated, add another Relay with Forcibly Guided Contacts or similar Relay in combination to provide redundancy and a self-monitoring function to the circuit (as shown in Fig. 2).

Refer to the *Safety Components Technical Guide* (Cat No. Y107). The G9S/G9SA/G9SB Safety Relay Unit, which combines Relays such as the Relay with Forcibly Guided Contacts in order to provide the above-described functions, is available for this purpose. By connecting a contactor with appropriate input and output to the Safety Relay Unit, the circuit can be equipped with redundancy and a self-monitoring function.

### CE Marking

(Source: *Guidelines on the Application of Council Directive 73/23/EEC*)

The G7SA, G7S and G7S-□-E have been recognized by the VDE for meeting the Low Voltage Directive according to EN requirements for relays and relays with forcibly guided contacts. The Low Voltage Directive, however, contains no clauses that specify handling methods for components, and interpretations vary among test sites and manufacturers. To solve this problem, the European Commission has created guidelines for the application of the Low Voltage Directive in EU. These guidelines present concepts for applying the Low Voltage Directive to components. The G7SA, G7S and G7S-□-E, however, do not display the CE Marking according to the concepts in the guidelines.

VDE recognition, however, has been obtained, so there should be no problems in obtaining the CE Marking for machines that use the G7SA, G7S or G7S-□-E. Use the manufacturer’s compliance declaration to prove standard conformance.

### Contents of the Guidelines

The *Guidelines on the Application of Council Directive 73/23/EEC* apply to components. Relays with PWB terminals are not covered by the Low Voltage Directive.

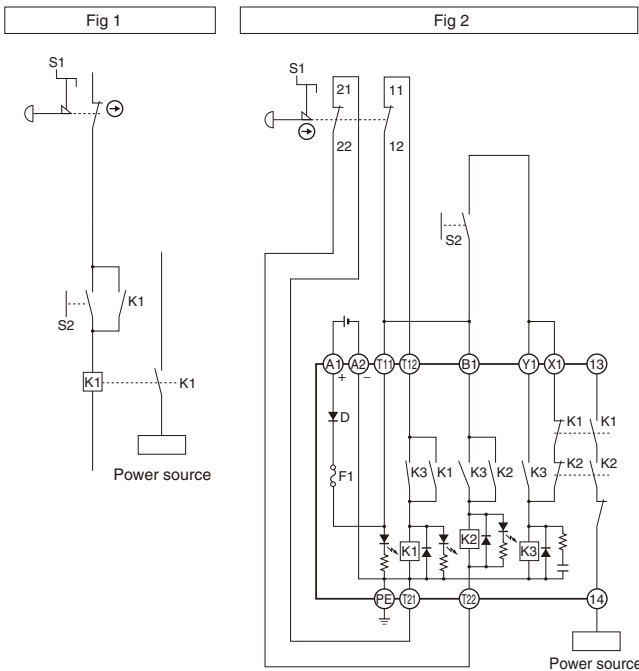

### Durability of Contact Outputs

Relay with Forcibly Guided Contact durability depends greatly on the switching condition. Confirm the actual conditions of operation in which the Relay will be used in order to make sure the permissible number of switching operations.

When the accumulated number of operation exceeds its permissible range, it can cause failure of reset of safety control circuit. In such case, please replace the Relay immediately. If the Relay is used continuously without replacing, then it can lead to loss of safety function.

# Precautions for All Relays

Refer to the *Safety Precautions* section for each Relay for specific precautions applicable to that Relay.

## Precautions for Safe Use

These precautions are required to ensure safe operation.

- Do not touch the charged Relay terminal area or the charged socket terminal area while the power is turned ON. Doing so may result in electric shock.
- Do not use a Relay for a load that exceeds the Relay's switching capacity or other contact ratings. Doing so will reduce the specified performance, causing insulation failure, contact welding, and contact failure, and the Relay itself may be damaged or burnt.
- Do not drop or disassemble Relays.  
Doing so may reduce Relay characteristics and may result in damage, electric shock, or burning.
- Relay durability depends greatly on the switching conditions. Confirm operation under the actual conditions in which the Relay will be used. Make sure the number of switching operations is within the permissible range. If a Relay is used after performance has deteriorated, it may result in insulation failure between circuits and burning of the Relay itself.
- Do not apply overvoltages or incorrect voltages to coils, or incorrectly wire the terminals. Doing so may prevent the Relay from functioning properly, may affect external circuits connected to the Relay, and may cause the Relay itself to be damaged or burnt.
- Do not use Relays where flammable gases or explosive gases may be present. Doing so may cause combustion or explosion due to Relay heating or arcing during switching.
- Perform wiring and soldering operations correctly and according to the instructions contained in *Precautions for Correct Use* given below. If a Relay is used with faulty wiring or soldering, it may cause burning due to abnormal heating when the power is turned ON.

## Precautions for Correct Use

### Contents

No.	Area	No.	Classification	No.	Item	Page
①	Using Relays					C-3
②	Selecting Relays	①	Mounting Structure and Type of Protection	1	Type of Protection	C-4
				2	Combining Relays and Sockets	
				3	Using Relays in Atmospheres Subject to Dust	
②	Drive Circuits	②		1	Providing Power Continuously for Long Periods	C-4
				2	Operation Checks for Inspection and Maintenance	
③	Loads	③		1	Contact Ratings	C-4
				2	Using Relays with a Microload	
③	Circuit Design	①	Load Circuits	1	Load Switching	C-5 to C-7
				①	Resistive Loads and Inductive Loads	
				②	Switching Voltage	
				③	Switching Current	
				2	Electrical Durability	
				3	Failure Rates	
				4	Contact Protection Circuits	
				5	Countermeasures for Surge from External Circuits	
				6	Connecting Loads for Multi-pole Relays	
				7	Motor Forward/Reverse Switching	
				8	Power Supply Double Break with Multi-pole Relays	
9	Short-circuiting Due to Arcing between NO and NC Contacts in SPDT Relays					
10	Using SPST-NO/SPST-NC Contact Relays as an SPDT Relay					
11	Connecting Loads of Differing Capacities					
②	Input Circuits	②		1	Maximum Allowable Voltage	C-7 to C-9
				2	Voltage Applied to Coils	
				3	Changes in Must-operate Voltage Due to Coil Temperature	
				4	Applied Voltage Waveform for Input Voltage	
				5	Preventing Surges when the Coil Is Turned OFF	
				6	Leakage Current to Relay Coils	
				7	Using with Infrequent Switching	
				8	Configuring Sequence Circuits	
				9	Connecting Relay Grounds	
				10	Individual Specifications for Must-operate/release Voltages and Operate/Release Times	
				11	Using DC-operated Relays, (1) Input Power Supply Ripple	
				12	Using DC-operated Relays, (2) Coil Polarity	
				13	Using DC-operated Relays, (3) Coil Voltage Insufficiency	
③	Mounting Design	③		1	Lead Wire Diameters	C-9
				2	When Sockets are Used	
				3	Mounting Direction	
				4	When Devices Such as Microcomputers are in Proximity	

No.	Area	No.	Classification	No.	Item	Page
④	Operating and Storage Environments			1	Operating, Storage, and Transport	C-9 to C-10
				2	Operating Atmosphere	
				3	Using Relays in an Atmosphere Containing Corrosive Gas (Silicon, Sulfuric, or Organic Gas)	
				4	Adhesion of Water, Chemicals, Solvent, and Oil	
				5	Vibration and Shock	
				6	External Magnetic Fields	
				7	External Loads	
				8	Adhesion of Magnetic Dust	
⑤	Relay Mounting Operations	①	Plug-in Relays	1	Panel-mounting Sockets	C-10
				2	Relay Removal Direction	
				3	Terminal Soldering	
		②	Printed Circuit Board Relays	1	Ultrasonic Cleaning	
				③	Common Items	
		2	Deformed Terminals			
		3	Replacing Relays and Performing Wiring Operations			
		4	Coating and Packing			
		⑥	Handling Relays			
2	Dropped Products					
⑦	Relays for Printed Circuit Boards (PCBs)			1	Selecting PCBs, (1) PCB Materials	C-11 to C-14
				2	Selecting PCBs, (2) PCB Thickness	
				3	Selecting PCBs, (3) Terminal Hole and Land Diameters	
				4	Mounting Space	
					① Ambient Temperature	
					② Mutual Magnetic Interference	
				5	Pattern Design for Noise Countermeasures	
					① Noise from Coils	
					② Noise from Contacts	
					③ High-frequency Patterns	
6	Shape of Lands					
7	Pattern Conductor Width and Thickness					
8	Conductor Pitch					
9	Securing the PCB					
10	Automatic Mounting of PCB Relays					
⑧	Troubleshooting					C-15

## ① Using Relays

- When actually using Relays, unanticipated failures may occur. It is therefore essential to test the operation is as wide of range as possible.
- Unless otherwise specified in this catalog for a particular rating or performance value, all values are based on JIS C5442 standard test conditions (temperature: 15 to 35°C, relative humidity: 25% to 75%, air pressure: 86 to 106 kPa). When checking operation in the actual application, do not merely test the Relay under the load conditions, but test it under the same conditions as in the actual operating environment and using the actual operating conditions.
- The reference data provided in this catalog represent actual measured values taken from samples of the production line and shown in diagrams. They are reference values only.
- Ratings and performance values given in this catalog are for individual tests and do not indicate ratings or performance values under composite conditions.

## ② Selecting Relays



### ① Mounting Structure and Type of Protection

#### ②-①-1 Type of Protection

If a Relay is selected that does not have the appropriate type of protection for the atmosphere and the mounting conditions, it may cause problems, such as contact failure.

Refer to the type of protection classifications shown in the following table and select a Relay suitable to the atmosphere in which it is to be used.

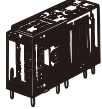
#### Classification by Type of Protection

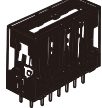
Mounting structure	Type of protection	Features	Representative model	Atmosphere conditions	
				Dust and dirt	Corrosive gases
PCB-mounted Relay	Flux protection	Structure that helps prevent flux from entering Relays during soldering	G7SA 	Some protection (No large dust or dirt particles inside Relay.)	No protection
			G7SB 		
	Unsealed	Structure that protects against contact with foreign material by means of enclosure in a case (designed for manual soldering)	G7S 		

#### ②-①-2 Combining Relays and Sockets

Use OMRON Relays in combination with specified OMRON Sockets. If the Relays are used with sockets from other manufacturers, it may cause problems, such as abnormal heating at the mating point due to differences in power capacity and mating properties.

#### ②-①-3 Using Relays in Atmospheres Subject to Dust

If a Relay is used in an atmosphere subject to dust, dust will enter the Relay, become lodged between contacts, and cause the circuit to fail to close. Moreover, if conductive material such as wire clippings enter the Relay, it will cause contact failure and short-circuiting.

Implement measures to protect against dust as required by the application.

### ② Drive Circuits

#### ②-②-1 Providing Power Continuously for Long Periods

If power is continuously provided to the coil for a long period, deterioration of coil insulation will be accelerated due to heating of the coil. Also see 3-2-7 Using with Infrequent Switching.

#### ②-②-2 Operation Checks for Inspection and Maintenance

If a socket with an operation indicator is used, Relay status during operation can be shown by means of the indicator, thereby facilitating inspection and maintenance.

Type	Description	Examples of applicable models
Built-in indicator	LED 	G7S G7SA

**Note:** The built-in indicator shows that power is being provided to the coil. The indicator is not based on contact operation.

### ③ Loads

#### ②-③-1 Contact Ratings

Contact ratings are generally shown for resistance loads and inductive loads.

#### ②-③-2 Using Relays with a Microload

Check the failure rate in the performance tables for individual products.



## ③ Circuit Design

### ① Load Circuits

#### ③-①-1 Load Switching

In actual Relay operation, the switching capacity, electrical durability, and applicable load will vary greatly with the type of load, the ambient conditions, and the switching conditions. Confirm operation under the actual conditions in which the Relay will be used.

##### ① Resistive Loads and Inductive Loads

The switching power for an inductive load will be lower than the switching power for a resistive load due to the influence of the electromagnetic energy stored in the inductive load.

##### ② Switching Voltage (Contact Voltage)

The switching power will be lower with DC loads than it will with AC loads. Applying voltage or current between the contacts exceeding the maximum values will result in the following:

1. The carbon generated by load switching will accumulate around the contacts and cause deterioration of insulation.
2. Contact deposits and locking will cause contacts to malfunction.

##### ③ Switching Current (Contact Current)





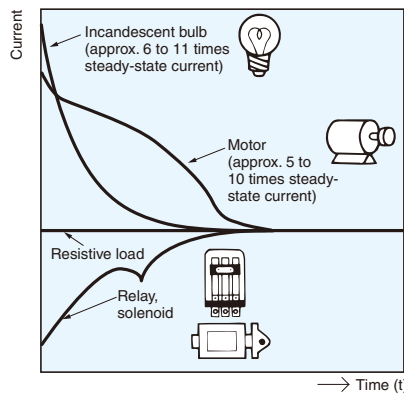

Current applied to contacts when they are open or closed will have a large effect on the contacts. For example, when the load is a motor or a lamp, the larger the inrush current, the greater the amount of contact exhaustion and contact transfer will be, leading to deposits, locking, and other factors causing the contacts to malfunction. (Typical examples illustrating the relationship between load and inrush current are given below.)

If a current greater than the rated current is applied and the load is from a DC power supply, the connection and shorting of arcing contacts will result in the loss of switching capability.

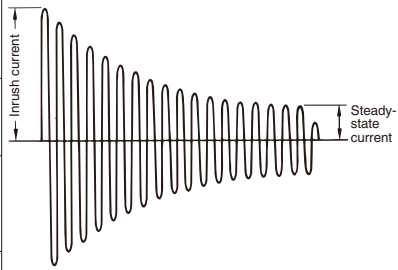
### DC Loads and Inrush Current



### AC Loads and Inrush Current

Type of load	Ratio of inrush current to steady-state current	Waveform
Solenoid 	Approx. 10	
Incandescent bulb 	Approx. 10 to 15	
Motor 	Approx. 5 to 10	
Relay 	Approx. 2 to 3	
Capacitor 	Approx. 20 to 50	
Resistive load 	1	

#### ③-①-2 Electrical Durability

Electrical durability will greatly depend on factors such as the coil drive circuit, type of load, switching frequency, switching phase, and ambient atmosphere. Therefore be sure to check operation in the actual application.

Coil drive circuit	Rated voltage applied to coil using instantaneous ON/OFF
Type of load	Rated load
Switching frequency	According to individual ratings
Switching phase (for AC load)	Random ON, OFF
Ambient atmosphere	According to JIS C5442 standard test conditions

#### ③-①-3 Failure Rates

The failure rates provided in this catalog are determined through tests performed under specified conditions. The values are reference values only. The values will depend on the operating frequency, the ambient atmosphere, and the expected level of reliability of the Relay. Be sure to check relay suitability under actual load conditions.

**④-①-4 Contact Protection Circuits**

Using a contact protection circuit is effective in increasing contact durability and minimizing the production of carbides and nitric acid. The following table shows typical examples of contact protection circuits. Use them as guidelines for circuit design.

1. Depending on factors such as the nature of the load and the Relay characteristics, the effects may not occur at all or adverse effects may result. Therefore be sure to check operation under the actual load conditions.
2. When a contact protection circuit is used, it may cause the release time (breaking time) to be increased. Therefore be sure to check operation under the actual load conditions.

**Typical Examples of Contact Protection Circuits**

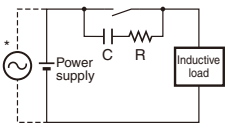
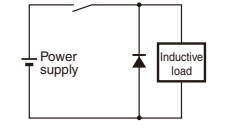
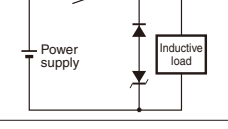
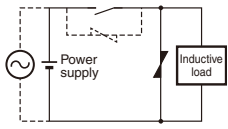
Circuit example	Applicable current		Features and remarks	Element selection
	AC	DC		
	* (Yes)	Yes	* Load impedance must be much smaller than the CR circuit impedance when using the Relay for an AC voltage. When the contacts are open, current flows to the inductive load via CR.	Use the following as guides for C and R values: C: 0.5 to 1 μF per 1 A of contact current (A) R: 0.5 to 1 Ω per 1 V of contact voltage (V) These values depend on various factors, including the load characteristics and variations in characteristics. Confirm optimum values experimentally. Capacitor C suppresses the discharge when the contacts are opened, while the resistor R limits the current applied when the contacts are closed the next time. Generally, use a capacitor with a dielectric strength of 200 to 300 V. For applications in an AC circuit, use an AC capacitor (with no polarity). If there is any question about the ability to cut off arcing of the contacts in applications with high DC voltages, it may be more effective to connect the capacitor and resistor across the contacts, rather than across the load. Perform testing with the actual equipment to determine this.
	No	Yes	The electromagnetic energy stored in the inductive load reaches the inductive load as current via the diode connected in parallel, and is dissipated as Joule heat by the resistance of the inductive load. This type of circuit increases the release time more than the CR type.	Use a diode having a reverse breakdown voltage of more than 10 times the circuit voltage, and a forward current rating greater than the load current. A diode having a reverse breakdown voltage two or three times that of the supply voltage can be used in an electronic circuit where the circuit voltage is not particularly high.
	No	Yes	This circuit effectively shortens the release time in applications where the release time of a diode circuit is too slow.	The breakdown voltage of the Zener diode should be about the same as the supply voltage.
	Yes	Yes	This circuit prevents a high voltage from being applied across the contacts by using the constant-voltage characteristic of a varistor. This circuit also somewhat increases the release time. Connecting the varistor across the load is effective when the supply voltage is 24 to 48 V, and across the contacts when the supply voltage is 100 to 200 V.	The cutoff voltage $V_c$ must satisfy the following conditions. For AC, it must be multiplied by $\sqrt{2}$ . $V_c > (\text{Supply voltage} \times 1.5)$ If $V_c$ is set too high, its effectiveness will be reduced because it will fail to cut off high voltages.

**Do not use the following types of contact protection circuit.**

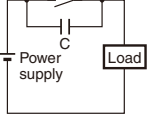
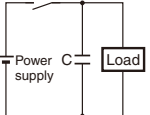
	<p>This circuit arrangement is very effective for diminishing arcing at the contacts when breaking the circuit. However, since electrical energy is stored in C (capacitor) when the contacts are open, the current from C flows into the contacts when they close. This may lead to contact welding.</p>
	<p>This circuit arrangement is very useful for diminishing arcing at the contacts when breaking the circuit. However, since the charging current to C flows into the contacts when they are closed, contact welding may occur.</p>

**Note:** Although it is thought that switching a DC inductive load is more difficult than a resistive load, an appropriate contact protection circuit can achieve almost the same characteristics.

**④-①-5 Countermeasures for Surge from External Circuits**

Install contact protection circuits, such as surge absorbers, at locations where there is a possibility of surges exceeding the Relay withstand voltage due to factors such as lightning. If a voltage exceeding the Relay withstand voltage value is applied, it will cause line and insulation deterioration between coils and contacts and between contacts of the same polarity.

### ③-①-6 Connecting Loads for Multi-pole Relays

Connect multi-pole Relay loads according to diagram "a" below to avoid creating differences in electric potential in the circuits. If a multi-pole Relay is used with an electric potential difference in the circuit, it will cause short-circuiting due to arcing between contacts, damaging the Relays and peripheral devices.

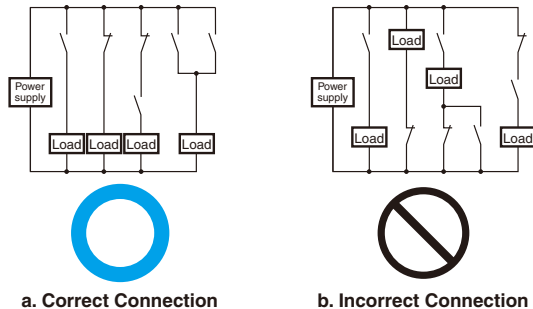

a. Correct Connection

b. Incorrect Connection

### ③-①-7 Motor Forward/Reverse Switching

Switching a motor between forward and reverse operation creates an electric potential difference in the circuit, so a time lag (OFF time) must be set up using multiple Relays.

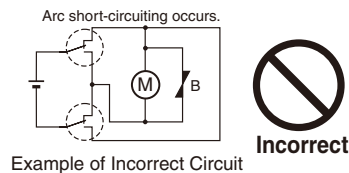

Example of Incorrect Circuit

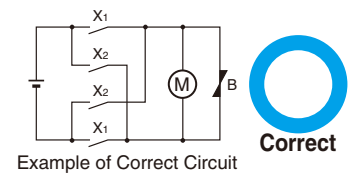

Example of Correct Circuit

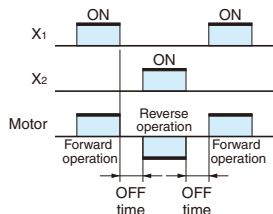

### ③-①-8 Power Supply Double Break with Multi-pole Relays

If a double break circuit for the power supply is constructed using multi-pole Relays, take factors into account when selecting models: Relay structure, creepage distance, clearance between unlike poles, and the existence of arc barriers. Also, after making the selection, check operation in the actual application. If an inappropriate model is selected, short-circuiting will occur between unlike poles even when the load is within the rated values, particularly due to arcing when power is turned OFF. This can cause burning and damage to peripheral devices.

### ③-①-9 Short-circuiting Due to Arcing between NO and NC Contacts in SPDT Relays

With Relays that have NO and NC contacts, short-circuiting between contacts will result due to arcing if the space between the NO and NC contacts is too small or if a large current is switched.

Do not construct a circuit in such a way that overcurrent and burning occur if the NO, NC, and SPDT contacts are short-circuited.

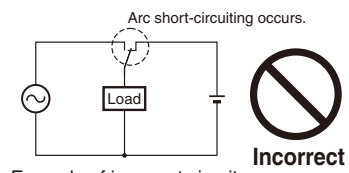

Example of incorrect circuit

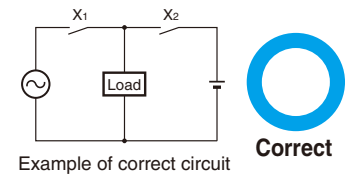

Example of correct circuit

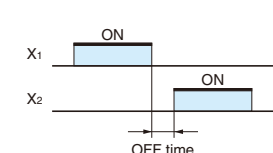

### ③-①-10 Using SPST-NO/SPST-NC Contact Relays as an SPDT Relay

Do not construct a circuit so that overcurrent and burning occur if the NO, NC and SPDT contacts are short-circuited.

Also, with SPST-NO/SPST-NC Relays, a short-circuit current may flow for forward/reverse motor operation.

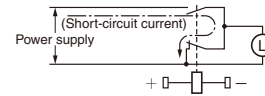

### ③-①-11 Connecting Loads of Differing Capacities

Do not have a single Relay simultaneously switching a large load and a microload.

The purity of the contacts used for microload switching will be lost as a result of the contact spattering that occurs during large load switching, and this may give rise to contact failure during microload switching.

## ② Input Circuits

### ③-②-1 Maximum Allowable Voltage

The coil's maximum allowable voltage is determined by the coil temperature increase and the heat withstand temperature of the insulation material. (If the heat withstand temperature is exceeded, it will cause coil burning and layer shorting.) There are also important restrictions imposed to prevent problems such as thermal changes and deterioration of the insulation, damage to other control devices, injury to humans, and fires, so be careful not to exceed the specified values provided in this catalog.

### ③-②-2 Voltage Applied to Coils

Apply only the rated voltage to coils. The Relays will operate at the must-operate voltage or greater, but the rated voltage must be applied to the coils in order to obtain the specified performance.

### ③-②-3 Changes in Must-operate Voltage Due to Coil Temperature

It may not be possible to satisfy this catalog values for must-operate voltages during a hot start or when the ambient temperature exceeds 23°C, so be sure to check operation under the actual application conditions.

Coil resistance is increased by a rise in temperature causing the must-operate voltage to increase. The resistance thermal coefficient of a copper wire is approximately 0.4% per 1°C, and the coil resistance also increases at this percentage.

This catalog values for the must-operate voltage and must-release voltage are given for a coil temperature of 23°C.

### ③-②-4 Applied Voltage Waveform for Input Voltage

As a rule, power supply waveforms are based on the rectangular (square) waveforms, and do not operate in such a way that the voltage applied to the coil slowly rises and falls. Also, do not use them to detect voltage or current limit values (i.e., using them for turning ON or OFF at the moment a voltage or current limit is reached).

This kind of circuit causes faulty sequence operations. For example, the simultaneous operability of contacts may not be dependable (for multi-pole Relays, time variations must occur in contact operations), and the must-operate voltage varies with each operation. In addition, the operation and release times are lengthened, causing durability to drop and contact welding. Be sure to use an instantaneous ON/OFF.

**③-②-5 Preventing Surges when the Coil Is Turned OFF**

Counter electromotive force generated from a coil when the coil is turned OFF causes damage to semiconductor elements and faulty operation.

As a countermeasure, install surge absorbing circuits at both ends of the coil. When surge absorbing circuits have been installed, the Relay release time will be lengthened, so be sure to check operation using the actual circuits.

External surges must be taken into account for the repetitive peak reverse voltage and the DC reverse voltage, and a diode with sufficient capacity used. Also, ensure that the diode has an average rectified current that is greater than the coil current.

Do not use under conditions in which a surge is included in the power supply, such as when an inductive load is connected in parallel to the coil. Doing so will cause damage to the installed (or built-in) coil surge absorbing diode.

**③-②-6 Leakage Current to Relay Coils**

Do not allow leakage current to flow to Relay coils. Construct a corrective circuit as shown in examples 1 and 2 below.

**Example: Circuit with Leakage Current Occurring**

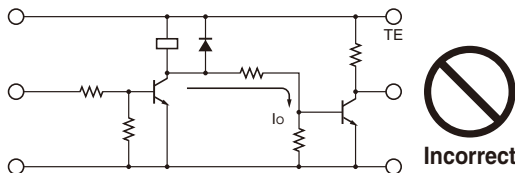

**Corrective Example 1**

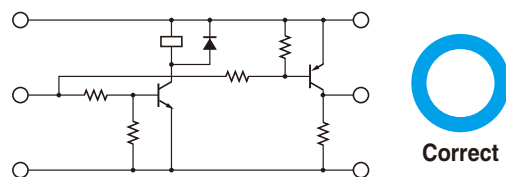

**Corrective Example 2:**

**When an Output Value Is Required in the Same Phase as the Input Value**

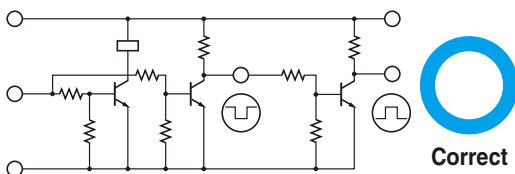

**③-②-7 Using with Infrequent Switching**

For operations using a microload and infrequent switching, periodically perform continuity tests on the contacts. When switching is not executed for contacts for long periods of time, it causes contact instability due to factors such as the formation of film on contact surfaces.

The frequency with which the inspections are needed will depend on factors such as the operating environment and the type of load.

**③-②-8 Configuring Sequence Circuits**

When configuring a sequence circuit, care must be taken to ensure that abnormal operation does not occur due to faults such as sneak current.

The following diagram shows an example of sneak current. After contacts A, B, and C are closed causing Relays X1, X2, and X3 to operate, and then contacts B and C are opened, a series circuit is created from A to X1 to X2 to X3. This causes the Relay to hum or to not release.

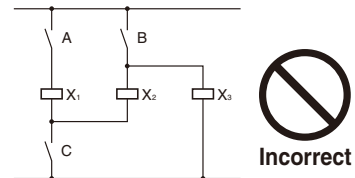

The following diagram shows an example of a circuit that corrects the above problem. Also, in a DC circuit, the sneak current can be prevented by means of a diode.

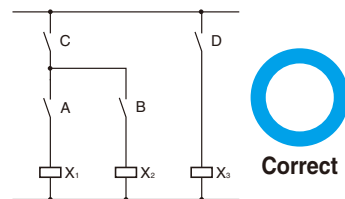

**③-②-9 Connecting Relay Grounds**

Do not connect a ground when using a Relay at high temperatures or high humidity. Depending on the grounding method, electrolytic corrosion may occur, causing the wire to the coil to sever. If the Relay must be grounded, use the method shown in the following diagrams.

- (1) Ground the positive side of the power supply. (Fig. 1 and Fig. 2)
- (2) If grounding the positive side of the power supply is not possible and the negative side must be grounded, connect a switch at the positive side so that the coil is connected to the negative side. (Fig. 3)
- (3) Do not ground the negative side and connect a switch to the negative side. This will cause electrolytic corrosion to occur. (Fig. 4)

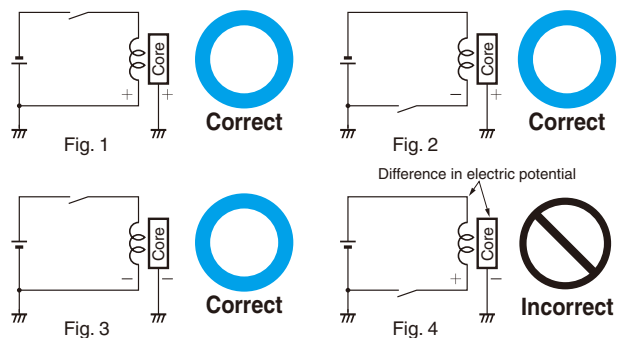

**③-②-10 Individual Specifications for Must-operate/ release Voltages and Operate/Release Times**

If it is necessary to know the individual specifications of characteristics, such as must-operate voltages, must-release voltages, operate times, and release times, please contact your OMRON representative.

### ③-②-11 Using DC-operated Relays (1) Input Power Supply Ripple

For a DC-operated Relay power supply, use a power supply with a maximum ripple percentage of 5%. An increase in the ripple percentage will cause humming.

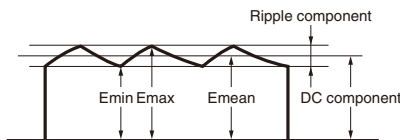
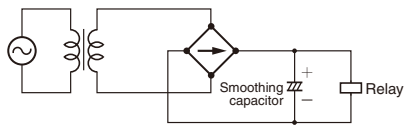

$$\text{Ripple percentage \%} = \frac{E_{\text{max}} - E_{\text{min}}}{E_{\text{mean}}} \times 100\%$$

$E_{\text{max}}$  = Maximum value of ripple component  
 $E_{\text{min}}$  = Minimum value of ripple component  
 $E_{\text{mean}}$  = Mean value of DC component

### ③-②-12 Using DC-operated Relays (2) Coil Polarity

To make the correct connections, first check the individual terminal numbers and applied power supply polarities provided in this catalog. If the polarity is connected in reverse for the coil power supply when Relays with surge suppressor diodes or Relays with operation indicators are used, it can cause problems such as Relay malfunctioning, damage to diodes, or failure of indicators. Also, for Relays with diodes, it can cause damage to devices in the circuit due to short-circuiting.

Polarized Relays that use a permanent magnet in a magnetic circuit will not operate if the power supply to the coil is connected in reverse.

### ③-②-13 Using DC-operated Relays (3) Coil Voltage Insufficiency

If insufficient voltage is applied to the coil, either the Relay will not operate or operation will be unstable. This will cause problems such as a drop in the electrical durability of the contacts and contact welding.

In particular, when a load with a large surge current, such as a large motor, is used, the voltage applied to the coil may drop when a large inrush current occurs to operate the load as the power is turned ON. Also, if a Relay is operated while the voltage is insufficient, it will cause the Relay to malfunction even at vibration and shock values below the specifications specified in the specification sheets and this catalog. Therefore, be sure to apply the rated voltage to the coil.

## ③ Mounting Design

### ③-③-1 Lead Wire Diameters

Lead wire diameters are determined by the size of the load current. As a standard, use lead wires at least the size of the cross-sectional areas shown in the following table. If the lead wire is too thin, it may cause burning due to abnormal heating of the wire.

Permissible current (A)	Cross-sectional area (mm <sup>2</sup> )
6	0.75
10	1.25
15	2
20	3.5

### ③-③-2 When Sockets are Used

Check Relay and socket ratings, and use devices at the lower end of the ratings. Relay and socket rated values may vary, and using devices at the high end of the ratings can result in abnormal heating and burning at connections.

### ③-③-3 Mounting Direction

Depending on the model, a particular mounting direction may be specified. Check this catalog and then mount the device in the correct direction.

### ③-③-4 When Devices Such as Microcomputers are in Proximity

If a device that is susceptible to external noise, such as a microcomputer, is located nearby, take noise countermeasures into consideration when designing the pattern and circuits. If Relays are driven using a device such as a microcomputer, and a large current is switched by Relay contacts, noise generated by arcing can cause the microcomputer to malfunction.

## ④ Operating and Storage Environments

### ④-1 Operating, Storage, and Transport

During operation, storage, and transport, avoid direct sunlight and maintain room temperature, humidity, and pressure.

- If Relays are used or stored for a long period of time in an atmosphere of high temperature and humidity, oxidation and sulphurization films will form on contact surfaces, causing problems such as contact failure.
- If the ambient temperature is suddenly changed in an atmosphere of high temperature and humidity, condensation will develop inside of the Relay. This condensation may cause insulation failure and deterioration of insulation due to tracking (an electric phenomenon) on the surface of the insulation material. Also, in an atmosphere of high humidity, with load switching accompanied by a comparatively large arc discharge, a dark green corrosive product may be generated inside of the Relay. To prevent this, it is recommended that Relays be used in at low humidity.
- If Relays are to be used after having been stored for a long period, first inspect the power transmission before use. Even if Relays are stored without being used at all, contact instability and obstruction may occur due to factors such as chemical changes to contact surfaces, and terminal soldering characteristics may be degraded.

### ④-2 Operating Atmosphere

- Do not use Relays in an atmosphere containing flammable or explosive gas. Arcs and heating resulting from Relay switching may cause fire or explosion.
- Do not use Relays in an atmosphere containing dust. The dust will get inside the Relays and cause contact failure.

### ④-3 Using Relays in an Atmosphere Containing Corrosive Gas (Silicon, Sulfuric, or Organic Gas)

Do not use Relays in a location where silicon gas, sulfuric gas (SO<sub>2</sub> or H<sub>2</sub>S), or organic gas is present.

If Relays are stored or used for a long period of time in an atmosphere of sulfuric gas or organic gas, contact surfaces may become corroded and cause contact instability and obstruction, and terminal soldering characteristics may be degraded.

Also, if Relays are stored or used for a long period of time in an atmosphere of silicon gas, a silicon film will form on contact surfaces, causing contact failure.

The effects of corrosive gas can be reduced by the processing shown in the following table.

Item	Processing
Outer case, housing	Seal structure using packing.
PCB, copper plating	Apply coating.
Connectors	Apply gold plating or rhodium plating.

**④-4 Adhesion of Water, Chemicals, Solvent, and Oil**

Do not use or store Relays in an atmosphere exposed to water, chemicals, solvent, or oil. If Relays are exposed to water or chemicals, it can cause rusting, corrosion, resin deterioration, and burning due to tracking. Also, if they are exposed to solvents such as thinner or gasoline, it can erase markings and cause components to deteriorate.

If oil adheres to the transparent case (polycarbonate), it can cause the case to cloud up or crack.

**④-5 Vibration and Shock**

Do not allow Relays to be subjected to vibration or shock that exceeds the rated values.

If abnormal vibration or shock is received, it will not only cause malfunctioning but faulty operation due to deformation of components in Relays, damage, etc. Mount Relays in locations and using methods that will not let them be affected by devices (such as motors) that generate vibration so that Relays are not subjected to abnormal vibration.

**④-6 External Magnetic Fields**

Do not use Relays in a location where an external magnetic field of 800 A/m or greater is present.

If they are used in a location with a strong magnetic field, it will cause malfunctioning.

Also, strong magnetic field may cause the arc discharge between contacts during switching to be bent or may cause tracking or insulation failure.

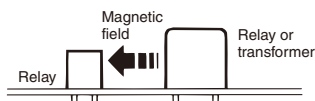
**④-7 External Loads**

Do not use or store Relays in such a way that they are subjected to external loads. The original performance capabilities of the Relays cannot be maintained if they are subjected to an external load.

**④-8 Adhesion of Magnetic Dust**

Do not use Relays in an atmosphere containing a large amount of magnetic dust. Relay performance cannot be maintained if magnetic dust adheres to the case.

**⑤ Relay Mounting Operations****① Plug-in Relays****⑤-①-1 Panel-mounting Sockets****1. Socket Mounting Screws**

When mounting a panel-mounting socket to the mounting holes, make sure that the screws are tightened securely.

If there is any looseness in the socket mounting screws, vibration and shock can cause the socket, Relays, and lead wire to detach. Panel-mounting sockets that can be snapped on to a 35-mm DIN Track are also available.

**2. Lead Wire Screw Connections**

Tighten lead wire screws to a torque of 0.78 to 0.98 N·m (P7SA and P7S).

If the screws connecting a panel-mounting socket are not sufficiently tightened, the lead wire can become detached and abnormal heating or fire can be caused by the contact failure. Conversely, excessive tightening can strip the threads.

**⑤-①-2 Relay Removal Direction**

Insert and remove Relays from the socket perpendicular to the socket surface.

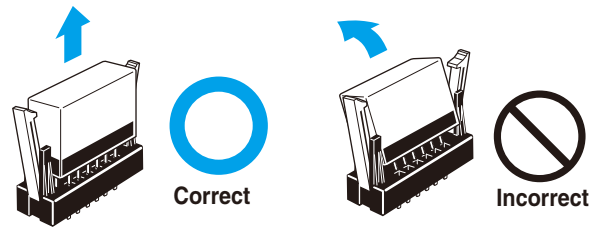

If they are inserted or removed at an angle, Relay terminals may be bent and may not make proper contact with the socket.

**⑤-①-3 Terminal Soldering**

Solder General-purpose Relays manually following the precautions described below.

- Smooth the tip of the solder gun and then begin the soldering.
  - Solder: JIS Z3282, H60A or H63A (containing rosin-based flux)
  - Soldering iron: Rated at 30 to 60 W
  - Tip temperature: 280 to 300°C
  - Soldering time: Approx. 3 s max.

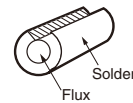

**Note:** For lead-free solder, perform the soldering under conditions that conform to the applicable specifications.

- Use a non-corrosive rosin-based flux suitable for the Relay's structural materials. For flux solvent, use an alcohol-based solvent, which tends to be less chemically reactive.
- As shown in the above illustration, solder is available with a cut section to prevent flux from splattering.

When soldering Relay terminals, be careful not to allow materials such as solder, flux, and solvent to adhere to areas outside of the terminals.

If this occurs, solder, flux, or solvent can penetrate inside of the Relays and cause degrading of the insulation and contact failure.

**② Printed Circuit Board Relays****⑤-②-1 Ultrasonic Cleaning**

Do not use ultrasonic cleaning for Relays that are not designed for it. Resonance from the ultrasonic waves used in ultrasonic cleaning can cause damage to a Relay's internal components, including sticking of contacts and disconnection of coils.

**③ Common Items****⑤-③-1 Removing the Case and Cutting Terminals**

Absolutely do not remove the case and cut terminals. Doing so will cause the Relay's original performance capabilities to be lost.

**⑤-③-2 Deformed Terminals**

Do not attempt to repair and use a terminal that has been deformed. Doing so will cause excessive force to be applied to the Relay, and the Relay's original performance capabilities will be lost.

**⑤-③-3 Replacing Relays and Performing Wiring Operations**

Before replacing a Relay or performing a wiring operation, first turn OFF the power to the coil and the load and check to make sure that the operation will be safe.

**⑤-③-4 Coating and Packing**

G7S, G7SA and G7SB Relays are not fully sealed, so do not use a coating or packing resin.

## ⑥ Handling Relays

### ⑥-1 Vibration and Shock

Relays are precision components. Regardless of whether or not they are mounted, do not exceed the rated values for vibration and shock. The vibration and shock values are determined individually for each Relay, so check the individual Relay specifications in this catalog. If a Relay is subjected to abnormal vibration or shock, its original performance capabilities will be lost.

### ⑥-2 Dropped Products

Do not use a product that has been dropped, or that has been taken apart. Not only may its characteristics not be satisfied, but it may be susceptible to damage or burning.

## ⑦ Relays for Printed Circuit Boards (PCBs)

### ⑦-1 Selecting PCBs

#### (1) PCB Materials

PCBs are classified into those made of epoxy and those made of phenol. The following table lists the characteristics of these PCBs. Select one, taking into account the application and cost. Epoxy PCBs are recommended for mounting Relays to prevent the solder from cracking.

Material	Epoxy		Phenol
	Glass epoxy (GE)	Paper epoxy (PE)	Paper phenol (PP)
Electrical characteristics	<ul style="list-style-type: none"> <li>High insulation resistance.</li> <li>Insulation resistance hardly affected by moisture absorption.</li> </ul>	Characteristics between glass epoxy and phenol	New PCBs are highly insulation-resistant but easily affected by moisture absorption.
Mechanical characteristics	<ul style="list-style-type: none"> <li>The dimensions are not easily affected by temperature or humidity.</li> <li>Suitable for through-hole or multi-layer PCBs.</li> </ul>	Characteristics between glass epoxy and phenol	<ul style="list-style-type: none"> <li>The dimensions are easily affected by temperature or humidity.</li> <li>Not suitable for through-hole PCBs.</li> </ul>
Relative cost	High	Moderate	Low
Applications	Applications that require high reliability.	Characteristics between glass epoxy and paper phenol	Applications in comparatively good environments with low-density wiring.

### ⑦-2 Selecting PCBs

#### (2) PCB Thickness

The PCB may warp due to the size, mounting method, or ambient operating temperature of the PCB or the weight of components mounted to the PCB. Should warping occur, the internal mechanism of the Relay on the PCB will be deformed and the Relay may not provide its full capability. Determine the thickness of the PCB by taking the material of the PCB into consideration. In general, PCB thickness should be 0.8, 1.2, 1.6, or 2.0 mm. Taking Relay terminal length into consideration, the optimum thickness is 1.6 mm.

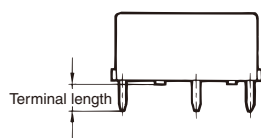

### ⑦-3 Selecting PCBs

#### (3) Terminal Hole and Land Diameters

Refer to the following table to select the terminal hole and land diameters based on the Relay mounting dimensions. The land diameter may be smaller if the land is processed with through-hole plating.

Terminal hole diameter (mm)		Minimum land diameter (mm)
Nominal value	Tolerance	
0.6	±0.1	1.5
0.8		1.8
1.0		2.0
1.2		2.5
1.3		2.5
1.5		3.0
1.6		3.0
2.0		3.0

### ⑦-4 Mounting Space

#### ① Ambient Temperature

When mounting a Relay, check this catalog for the specified amount of mounting space for that Relay, and be sure to allow at least that much space.

When two or more Relays are mounted, their interaction may generate excessive heat. In addition, if multiple PCBs with Relays are mounted to a rack, the temperature may rise excessively. When mounting Relays, leave enough space so that heat will not build up, and so that the Relays' ambient temperature remains within the specified operating temperature range.

#### ② Mutual Magnetic Interference

When two or more Relays are mounted, Relay characteristics may be changed by interference from the magnetic fields generated by the individual Relays. Be sure to conduct tests using the actual devices.

### ⑦-5 Pattern Design for Noise Countermeasures

#### ① Noise from Coils

When the coil is turned OFF, reverse power is generated to both ends of the coil and a noise spike occurs. As a countermeasure, connect a surge absorbing diode. The diagram below shows an example of a circuit for reducing noise propagation.

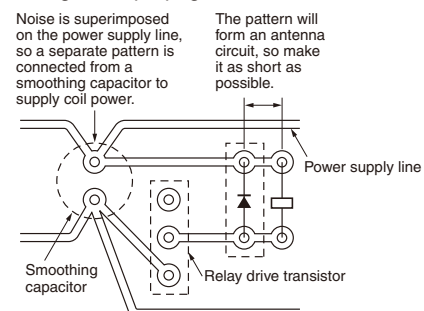

② **Noise from Contacts**

Noise may be transmitted to the electronic circuit when switching a load, such as a motor or transistor, that generates a surge at the contacts. When designing patterns, take the following three points into consideration.

1. Do not place a signal transmission pattern near the contact pattern.
2. Shorten the length of patterns that may be sources of noise.
3. Block noise from electronic circuits by means such as constructing ground patterns.

③ **High-frequency Patterns**

As the manipulated frequency is increased, pattern mutual interference also increases. Therefore, take noise countermeasures into consideration when designing high-frequency pattern and land shapes.

⑦-6 **Shape of Lands**

1. The land section should be on the center line of the copper-foil pattern, so that the soldered fillets become uniform.

<b>Correct Examples</b>	
<b>Incorrect Examples</b>	

2. A break in the circular land area will prevent molten solder from filling holes reserved for components which must be soldered manually after the automatic soldering of the PCB is complete.



⑦-7 **Pattern Conductor Width and Thickness**

The following thicknesses of copper foil are standard: 35 μm and 70 μm. The conductor width is determined by the current flow and allowable temperature rise. Refer to the chart below as a simple guideline.

**Conductor Width and Permissible Current (According to IEC Pub326-3)**

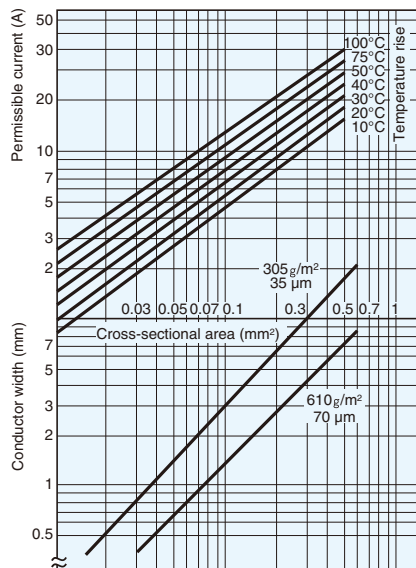

⑦-8 **Conductor Pitch**

The conductor pitch on a PCB is determined by the insulation characteristics between conductors and the environmental conditions under which the PCB is to be used. Refer to the following graph. If the PCB must conform to safety organization standards (such as UL, CSA, or IEC), however, priority must be given to fulfilling their requirements. Also, multi-layer PCBs can be used as a means of increasing the conductor pitch.

**Voltage between Conductors vs. Conductor Pitch (According to IEC Pub326-3)**

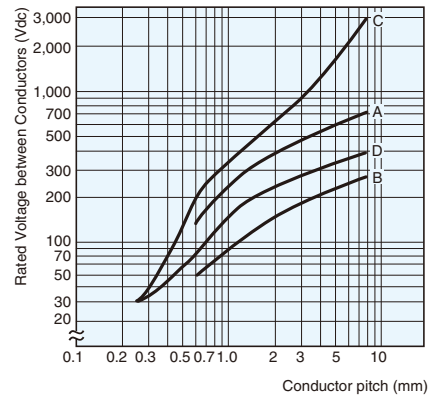

- A = Without coating at altitude of 3,000 m max.
- B = Without coating at altitude of 3,000 m or higher but lower than 15,000 m
- C = With coating at altitude of 3,000 m max.
- D = With coating at altitude of 3,000 m or higher

⑦-9 **Securing the PCB**

Although the PCB itself is not normally a source of vibration or shock, it may prolong vibration or shock by resonating with external vibration or shock.

Securely fix the PCB, paying attention to the following points.

Mounting method	Process
Rack mounting	No gap between rack's guide and PCB
Screw mounting	<ul style="list-style-type: none"> <li>• Securely tighten screw.</li> <li>Place heavy components such as Relays on part of PCB near where screws are to be used.</li> <li>• Attach rubber washers to screws when mounting components that are affected by shock (such as audio devices.)</li> </ul>



### ⑦-10 Automatic Mounting of PCB Relays

#### ① Through-hole PCBs

When mounting a Relay to a PCB, take the following points into consideration for each process. There are also certain mounting precautions for individual Relays, so refer to the individual Relay precautions as well.

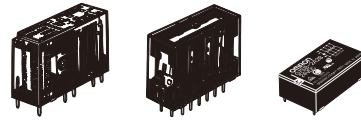

**Process 1**  
Placement

1. Do not bend any terminals of the Relay to use it as a self-clinching Relay. The initial performance characteristics of the Relay will be lost.
2. Execute PCB processing correctly according to the PCB process diagrams.

**Process 2**  
Flux Application

1. The G7S has no protection against flux penetration, so absolutely do not use the method shown in the diagram on the right, in which a sponge is soaked with flux and the PCB pressed down on the sponge. If this method is used for the G7S, it will cause the flux to penetrate into the Relay. Be careful even with the flux-resistant G7SA or G7SB, because flux can penetrate into the Relay if it is pressed too deeply into the sponge.
2. The flux must be a non-corrosive rosin-based flux suitable for the Relay's structural materials. For the flux solvent, use an alcohol-based solvent, which tends to be less chemically reactive. Apply the flux sparingly and evenly to prevent penetration into the Relay. When dipping the Relay terminals into liquid flux, be sure to adjust the flux level, so that the upper surface of the PCB is not flooded with flux.

3. Make sure that flux does not adhere anywhere outside of the Relay terminals. If flux adheres to an area such as the bottom surface of the Relay, it will cause the insulation to deteriorate.

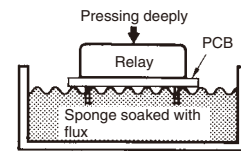

Example of incorrect method

Applicability of Dipping Method

G7S	G7SA	G7SB
NO	YES (Must be checked when spray flexor is used.)	

**Process 3**  
Preheating

1. Preheating is required to create the optimum conditions for soldering.
2. The following conditions apply for preheating.

<b>Temperature</b>	100°C max.
<b>Time</b>	1 min max.

3. Do not use a Relay if it has been left at a high temperature for a long period of time due to a circumstance such as equipment failure. These conditions will cause the Relay's initial characteristics to change.

Applicability of Preheating

G7S	G7SA	G7SB
NO	YES	

**Process 4**  
Soldering

Automatic soldering			Manual soldering		
<ol style="list-style-type: none"> <li>1. Flow soldering is recommended to assure a uniform solder joint.                             <ul style="list-style-type: none"> <li>• Solder: JIS Z3282 or H63A</li> <li>• Solder temperature and soldering time: Approx. 250°C (DWS: Approx. 260°C)</li> <li>• Solder time: 5 s max. (DWS: Approx. 2 s for first time and approx. 3 s for second time)</li> <li>• Adjust the level of the molten solder so that the PCB is not flooded with solder.</li> </ul> </li> </ol>			<ol style="list-style-type: none"> <li>1. Smooth the solder with the tip of the iron, and then perform the soldering under the following conditions.                             <ul style="list-style-type: none"> <li>• Solder: JIS Z3282, H60A, or H63A (containing rosin-based flux)</li> <li>• Soldering iron: Rated at 30 to 60 W</li> <li>• Tip temperature: 280 to 300°C</li> <li>• Soldering time: Approx. 3 s max.</li> </ul> </li> <li>2. As shown in the above illustration, solder is available with a cut section to prevent flux from splattering.</li> </ol>		
Applicability of Automatic Soldering			Applicability of Manual Soldering		
<b>G7S</b>	<b>G7SA</b>	<b>G7SB</b>	<b>G7S</b>	<b>G7SA</b>	<b>G7SB</b>
NO	YES		YES	YES	

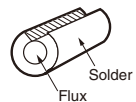

Continued next page.

**Note:** For lead-free solder, perform the soldering under conditions that conform to the applicable specifications.

**Process 5**  
Cooling

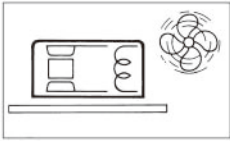

**Process 6**  
Cleaning

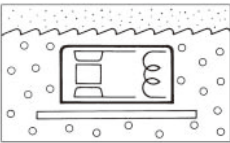

**Process 7**  
Coating

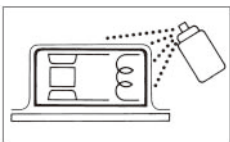

1. Upon completion of automatic soldering, use a fan or other device to forcibly cool the PCB. This helps prevent the Relay and other components from deteriorating from the residual heat of soldering.
2. Fully sealed relays are washable. Do not, however, put fully sealed relays in a cold cleaning solvent immediately after soldering or the seals may be damaged.

Cooling

G7SA	G7SB
Required	

Refer to the following table to select the cleaning method and solvent.

Cleaning Method

G7S	G7SA	G7SB
Neither boiling cleaning nor immersion cleaning is possible. Clean only the back of the PCB with a brush.		

1. With the G7S, G7SA or G7SB coating will penetrate inside Relays and damage the contacts. Therefore either do not apply coating at all or apply the coating first, before mounting the Relays.
2. Be very careful in selecting the coating material. Depending on the type of coating selected, it may damage the Relay case and chemically dissolve the seals, causing them to lose their sealing capability.

3. Do not secure the entire Relay in resin, or the Relay's characteristics will be changed. Do not exceed the maximum value for the coating's ambient operating temperature.

## ⑧ Troubleshooting

The following table can be used for troubleshooting when Relay operation is not normal. Refer to this table when checking the circuit and other items.

If checking the circuit reveals no abnormality, and it appears that the fault is caused by a Relay, contact your OMRON representative. (Do not disassemble the Relay. Doing so will make it impossible to identify the cause of the problem.)

A Relay is composed of various mechanical parts, including a coil, contacts, and iron core. Among these, problems occur most often with the contacts, and next often with the coil.

These problems, however, mostly occur as a result of external factors such as methods and conditions of operation, and can generally be prevented by means of careful consideration before operation and by selecting the correct Relays.

The following table shows the main faults that may occur, their probable causes, and suggested countermeasures to correct them.

Fault	Probable cause	Countermeasures
(1) Operation fault	<ol style="list-style-type: none"> <li>1. Incorrect coil rated voltage selected</li> <li>2. Faulty wiring</li> <li>3. Input signal not received</li> <li>4. Power supply voltage drop</li> <li>5. Circuit voltage drop (Be careful in particular of high-current devices operated nearby or wired at a distance.)</li> <li>6. Rise in operating voltage along with rise in ambient operating temperature (especially for DC)</li> <li>7. Coil disconnection</li> </ol>	<ol style="list-style-type: none"> <li>1. Select the correct rated voltage.</li> <li>2. Check the voltage between coil terminals.</li> <li>3. Check the voltage between coil terminals.</li> <li>4. Check the power supply voltage.</li> <li>5. Check the circuit voltage.</li> <li>6. Test individual Relay operation.</li> <li>7. <ul style="list-style-type: none"> <li>• For coil burning, see fault (3).</li> <li>• For disconnection due to electrical corrosion, check the polarity being applied to the coil voltage.</li> </ul> </li> </ol>
(2) Release fault	<ol style="list-style-type: none"> <li>1. Input signal OFF fault</li> <li>2. Voltage is applied to the coil by a sneak current</li> <li>3. Residual voltage by a combination circuit such as a semiconductor circuit</li> <li>4. Release delay due to parallel connection of coil and capacitor</li> <li>5. Contact welding</li> </ol>	<ol style="list-style-type: none"> <li>1. Check the voltage between coil terminals.</li> <li>2. Check the voltage between coil terminals.</li> <li>3. Check the voltage between coil terminals.</li> <li>4. Check the voltage between coil terminals.</li> <li>5. For contact welding, see fault (4).</li> </ol>
(3) Coil burning	<ol style="list-style-type: none"> <li>1. Unsuitable voltage applied to coil</li> <li>2. Incorrect rated voltage selected</li> <li>3. Short-circuit between coil layers</li> </ol>	<ol style="list-style-type: none"> <li>1. Check the voltage between coil terminals.</li> <li>2. Select the correct rated voltage.</li> <li>3. Recheck the operating atmosphere.</li> </ol>
(4) Contact welding	<ol style="list-style-type: none"> <li>1. Excessive device load connected (insufficient contact capacity)</li> <li>2. Excessive switching frequency</li> <li>3. Short-circuiting of load circuit</li> <li>4. Abnormal contact switching due to humming</li> <li>5. Expected service life of contacts reached</li> </ol>	<ol style="list-style-type: none"> <li>1. Check the load capacity.</li> <li>2. Check the number of switches.</li> <li>3. Check the load circuits.</li> <li>4. For humming, see fault (7).</li> <li>5. Check the contact ratings.</li> </ol>
(5) Contact failure	<ol style="list-style-type: none"> <li>1. Oxidation of contact surfaces</li> <li>2. Contact abrasion and aging</li> <li>3. Terminal and contact displacement due to faulty handling</li> </ol>	<ol style="list-style-type: none"> <li>1. <ul style="list-style-type: none"> <li>• Recheck the operating atmosphere.</li> <li>• Select the correct Relay.</li> </ul> </li> <li>2. The expected service life of the contacts has been reached.</li> <li>3. Be careful of vibration, shock, and soldering operations.</li> </ol>
(6) Abnormal contact consumption	<ol style="list-style-type: none"> <li>1. Unsuitable Relay selection</li> <li>2. Insufficient consideration of device load (especially motor, solenoid, and lamp loads)</li> <li>3. No contact protection circuit</li> <li>4. Insufficient withstand voltage between adjacent contacts</li> </ol>	<ol style="list-style-type: none"> <li>1. Select the correct Relay.</li> <li>2. Select the correct devices.</li> <li>3. Add a circuit such as a spark quenching circuit.</li> <li>4. Select the correct Relay.</li> </ol>
(7) Humming	<ol style="list-style-type: none"> <li>1. Insufficient voltage applied to coil</li> <li>2. Excessive power supply ripple (DC)</li> <li>3. Incorrect coil rated voltage selected</li> <li>4. Slow rise in input voltage</li> <li>5. Abrasion in iron core</li> <li>6. Foreign material between moveable iron piece and iron core</li> </ol>	<ol style="list-style-type: none"> <li>1. Check the voltage between coil terminals.</li> <li>2. Check the ripple percentage.</li> <li>3. Select the correct rated voltage.</li> <li>4. Make supplemental changes to circuit.</li> <li>5. The expected service life has been reached.</li> <li>6. Remove the foreign material.</li> </ol>



## WARNING

This catalog is a guide to help customers select the proper safety products. Observe the following items when choosing products, select the right products for your devices or equipment, and develop a safety-related system to fully utilize product functions.

### Setting Up a Risk Assessment System

The items listed in this catalog must be used properly in terms of product location as well as product performance and functionality. Part of the process of selecting and using these products should include the introduction and development of a risk assessment system early in the design development stage to help identify potential dangers in your equipment that will optimize safety product selection. A badly designed risk assessment system often results in poor choices when it comes to safety products.

- Related International Standards:  
ISO 14121 Principles of Risk Assessment

### Safety Policy

When developing a safety system for the devices and equipment that use safety products, make every effort to understand and conform to the entire series of international and industrial standards available, such as the examples given below.

- Related International Standards:  
ISO 12100 Basic Concepts, General Principles for Design  
IEC 61508 Functional Safety of Electrical/Electronic/Programmable Electronic Safety-related Systems

### Role of Safety Products

Safety products have functions and mechanisms that ensure safety as defined by standards. These functions and mechanisms are designed to attain their full potential within safety-related systems. Make sure you fully understand all functions and mechanisms, and use that understanding to develop systems that will ensure optimal usage.

- Related International Standards:  
ISO 14119 Interlocking Devices Associated with Guards-Principles for Design and Selection

### Installing Safety Products

Make sure that properly educated and trained engineers are selected to develop your safety-related system and to install safety products in devices and equipment.

- Related International Standards:  
ISO 12100 Basic Concepts, General Principles for Design  
IEC 61508 Functional Safety of Electrical/Electronic/Programmable Electronic Safety-related Systems

### Observing Laws and Regulations

Safety products should conform to pertinent laws, regulations, and standards, but make sure that they are used in accordance with the laws, regulations, and standards of the country where the devices and equipment incorporating these products are distributed.

- Related International Standards:  
IEC 60204 Electrical Equipment of Machines

### Observing Usage Precautions

Carefully read the specifications and precautions listed in this catalog for your product as well as all items in the Operating Manual packed with the product to learn usage procedures that will optimize your choice. Any deviation from precautions will lead to unexpected device or equipment failure not anticipated by safety-related systems or fire originating from equipment failure.

### Transferring Devices and Equipment

When transferring devices and equipment, be sure to keep one copy of the Operating Manual and pack another copy with the device or equipment so the person receiving it will have no problem operating it.

- Related International Standards:  
ISO 12100 Basic Concepts, General Principles for Design  
IEC 61508 Functional Safety of Electrical/Electronic/Programmable Electronic Safety-related Systems

## Read and Understand This Catalog

Please read and understand this catalog before purchasing the products. Please consult your OMRON representative if you have any questions or comments.

## Warranty and Limitations of Liability

### WARRANTY

OMRON's exclusive warranty is that the products are free from defects in materials and workmanship for a period of one year (or other period if specified) from date of sale by OMRON.

OMRON MAKES NO WARRANTY OR REPRESENTATION, EXPRESS OR IMPLIED, REGARDING NON-INFRINGEMENT, MERCHANTABILITY, OR FITNESS FOR PARTICULAR PURPOSE OF THE PRODUCTS. ANY BUYER OR USER ACKNOWLEDGES THAT THE BUYER OR USER ALONE HAS DETERMINED THAT THE PRODUCTS WILL SUITABLY MEET THE REQUIREMENTS OF THEIR INTENDED USE. OMRON DISCLAIMS ALL OTHER WARRANTIES, EXPRESS OR IMPLIED.

### LIMITATIONS OF LIABILITY

OMRON SHALL NOT BE RESPONSIBLE FOR SPECIAL, INDIRECT, OR CONSEQUENTIAL DAMAGES, LOSS OF PROFITS, OR COMMERCIAL LOSS IN ANY WAY CONNECTED WITH THE PRODUCTS, WHETHER SUCH CLAIM IS BASED ON CONTRACT, WARRANTY, NEGLIGENCE, OR STRICT LIABILITY.

In no event shall responsibility of OMRON for any act exceed the individual price of the product on which liability is asserted.

IN NO EVENT SHALL OMRON BE RESPONSIBLE FOR WARRANTY, REPAIR, OR OTHER CLAIMS REGARDING THE PRODUCTS UNLESS OMRON'S ANALYSIS CONFIRMS THAT THE PRODUCTS WERE PROPERLY HANDLED, STORED, INSTALLED, AND MAINTAINED AND NOT SUBJECT TO CONTAMINATION, ABUSE, MISUSE, OR INAPPROPRIATE MODIFICATION OR REPAIR.

## Application Considerations

### SUITABILITY FOR USE

OMRON shall not be responsible for conformity with any standards, codes, or regulations that apply to the combination of products in the customer's application or use of the product.

At the customer's request, OMRON will provide applicable third party certification documents identifying ratings and limitations of use that apply to the products. This information by itself is not sufficient for a complete determination of the suitability of the products in combination with the end product, machine, system, or other application or use.

The following are some examples of applications for which particular attention must be given. This is not intended to be an exhaustive list of all possible uses of the products, nor is it intended to imply that the uses listed may be suitable for the products:

- Outdoor use, uses involving potential chemical contamination or electrical interference, or conditions or uses not described in this catalog.
- Nuclear energy control systems, combustion systems, railroad systems, aviation systems, medical equipment, amusement machines, vehicles, safety equipment, and installations subject to separate industry or government regulations.
- Systems, machines, and equipment that could present a risk to life or property.

Please know and observe all prohibitions of use applicable to the products.

NEVER USE THE PRODUCTS FOR AN APPLICATION INVOLVING SERIOUS RISK TO LIFE OR PROPERTY WITHOUT ENSURING THAT THE SYSTEM AS A WHOLE HAS BEEN DESIGNED TO ADDRESS THE RISKS, AND THAT THE OMRON PRODUCT IS PROPERLY RATED AND INSTALLED FOR THE INTENDED USE WITHIN THE OVERALL EQUIPMENT OR SYSTEM.

## Disclaimers

### CHANGE IN SPECIFICATIONS

Product specifications and accessories may be changed at any time based on improvements and other reasons.

It is our practice to change model numbers when published ratings or features are changed, or when significant construction changes are made. However, some specifications of the product may be changed without any notice. When in doubt, special model numbers may be assigned to fix or establish key specifications for your application on your request. Please consult with your OMRON representative at any time to confirm actual specifications of purchased product.

### DIMENSIONS AND WEIGHTS

Dimensions and weights are nominal and are not to be used for manufacturing purposes, even when tolerances are shown.

### ERRORS AND OMISSIONS

The information in this catalog has been carefully checked and is believed to be accurate; however, no responsibility is assumed for clerical, typographical, or proofreading errors, or omissions.

### PERFORMANCE DATA

Performance data given in this catalog is provided as a guide for the user in determining suitability and does not constitute a warranty. It may represent the result of OMRON's test conditions, and the users must correlate it to actual application requirements. Actual performance is subject to the OMRON Warranty and Limitations of Liability.

### PROGRAMMABLE PRODUCTS

OMRON shall not be responsible for the user's programming of a programmable product, or any consequence thereof.

### COPYRIGHT AND COPY PERMISSION

This catalog shall not be copied for sales or promotions without permission.

This catalog is protected by copyright and is intended solely for use in conjunction with the product. Please notify us before copying or reproducing this catalog in any manner, for any other purpose. If copying or transmitting this catalog to another, please copy or transmit it in its entirety.