

Cat. No. W349-E2-2

**C200HW-PRM21**

**PROFIBUS-DP Master Unit**

**OPERATION MANUAL**

**OMRON**







**C200HW-PRM21**  
**PROFIBUS-DP Master Unit**  
**Operation Manual**



*Produced May 2000*



## **Notice:**

OMRON products are manufactured for use according to proper procedures by a qualified operator and only for the purposes described in this manual.

The following conventions are used to indicate and classify precautions in this manual. Always heed the information provided with them. Failure to heed precautions can result in injury to people or damage to the product.

-  **DANGER!** Indicates information that, if not heeded, is likely to result in loss of life or serious injury.
-  **WARNING** Indicates information that, if not heeded, could possibly result in loss of life or serious injury.
-  **Caution** Indicates information that, if not heeded, could result in relatively serious or minor injury, damage to the product, or faulty operation.

## **OMRON Product References**

All OMRON products are capitalised in this manual. The word “Unit” is also capitalised when it refers to an OMRON product, regardless of whether or not it appears in the proper name of the product.

The abbreviation “Ch,” which appears in some displays and on some OMRON products, often means “word” and is abbreviated “Wd” in documentation in this sense.

The abbreviation “PLC” means Programmable Logic Controller and is not used as an abbreviation for anything else.

## **Visual Aids**

The following headings appear in the left column of the manual to help you locate different types of information.

**Note** Indicates information of particular interest for efficient and convenient operation of the product.

**1, 2, 3...**Indicates lists of one sort or another, such as procedures, checklists, etc.

## **© OMRON, 2000**

All rights reserved. No part of this publication may be reproduced, stored in a retrieval system, or transmitted, in any form, or by any means, mechanical, electronic, photocopying, recording, or otherwise, without the prior written permission of OMRON.

No patent liability is assumed with respect to the use of the information contained herein. Moreover, because OMRON is constantly striving to improve its high-quality products, the information contained in this manual is subject to change without notice. Every precaution has been taken in the preparation of this manual. Nevertheless, OMRON assumes no responsibility for errors or omissions. Neither is any liability assumed for damages resulting from the use of the information contained in this publication.





# TABLE OF CONTENTS

<b>PRECAUTIONS .....</b>	<b>xi</b>
1 Intended Audience .....	xii
2 General Precautions .....	xii
3 Safety Precautions .....	xii
4 Operating Environment Precautions .....	xii
5 Application Precautions .....	xiii
6 EC Directives .....	xiv
<b>1 PROFIBUS-DP .....</b>	<b>1</b>
1-1 Introduction .....	2
1-2 Protocol architecture .....	2
1-3 Device types .....	4
1-4 PROFIBUS-DP characteristics .....	4
1-5 Device Data Base files .....	8
1-6 Profiles .....	8
<b>2 INSTALLATION .....</b>	<b>9</b>
2-1 Physical layout of the unit .....	10
2-2 Mounting the C200HW-PRM21 .....	13
2-3 Setting up a network .....	14
<b>3 SPECIFICATIONS AND PERFORMANCE .....</b>	<b>17</b>
3-1 Overall Specifications .....	18
3-2 Performance .....	20
<b>4 CONFIGURATOR .....</b>	<b>29</b>
4-1 General .....	30
4-2 Setup .....	31
4-3 Operation .....	32
4-4 Debug mode .....	46
<b>5 PLC INTERFACE .....</b>	<b>51</b>
5-1 Unit Settings .....	52
5-2 Input / Output Mailbox .....	59
5-3 Control and status area .....	60
5-4 LEDs .....	70
<b>6 MESSAGE COMMUNICATION, IOWR / IORD .....</b>	<b>73</b>
6-1 Message communication .....	74
6-2 IOWR .....	74
6-3 IORD .....	76
6-4 Messages .....	77
<b>7 TROUBLESHOOTING AND MAINTENANCE .....</b>	<b>83</b>
7-1 Error Indicators .....	84
7-2 Troubleshooting .....	84
7-3 Maintenance .....	90

<b>Appendices .....</b>	<b>93</b>
Appendix A	Tips and sample programs .....93
Appendix B	GSD file for C200HW-PRM21 .....101
Appendix C	CS1 PLC series compatibility .....103
<b>Index .....</b>	<b>105</b>
<b>Revision History .....</b>	<b>107</b>

## ***About this Manual:***

This manual describes the installation and operation of the PROFIBUS-DP Master Unit and includes the sections described below.

Please read this manual carefully and be sure you understand the information provided before attempting to install and operate the PROFIBUS-DP Master Unit. **Be sure to read the precautions provided in the following section.**

**Section 1** gives a brief description of PROFIBUS-DP.

**Section 2** describes the installation of the C200HW-PRM21.

**Section 3** describes the overall specifications and the communication performance of the Unit.

**Section 4** describes the software for configuring the PROFIBUS-DP network.

**Section 5** describes the interface with the user.

**Section 6** describes the message communication.

**Section 7** describes the troubleshooting procedures and maintenance operations.

### **WARNING**

Failure to read and understand the information provided in this manual may result in personal injury or death, damage to the product, or product failure. Please read each section in its entirety and be sure you understand the information provided in the section and related sections before attempting any of the procedures or operations given.



# PRECAUTIONS

This section provides general precautions for using the PROFIBUS-DP Master Units, Programmable Controllers, and related devices.

**The information contained in this section is important for the safe and reliable application of the PROFIBUS-DP Master Units. You must read this section and understand the information contained before attempting to set up or operate a PROFIBUS-DP Master Unit and PLC system.**

1 Intended Audience .....	xii
2 General Precautions .....	xii
3 Safety Precautions .....	xii
4 Operating Environment Precautions .....	xii
5 Application Precautions .....	xiii
6 EC Directives .....	xiv

### 1 Intended Audience

This manual is intended for the following personnel, who must also have knowledge of electrical systems (an electrical engineer or the equivalent).

- Personnel in charge of installing FA systems.
- Personnel in charge of designing FA systems.
- Personnel in charge of managing FA systems and facilities.

### 2 General Precautions

The user must operate the product according to the performance specifications described in the operation manuals.

Before using the product under conditions which are not described in the manual or applying the product to nuclear control systems, railroad systems, aviation systems, vehicles, combustion systems, medical equipment, amusement machines, safety equipment, and other systems, machines, and equipment that may have a serious influence on lives and property if used improperly, consult your OMRON representative.

Make sure that the ratings and performance characteristics of the product are sufficient for the systems, machines, and equipment, and be sure to provide the systems, machines, and equipment with double safety mechanisms.

This manual provides information for installing and operating OMRON PROFIBUS-DP Master Units. Be sure to read this manual before operation and keep this manual close at hand for reference during operation.

 **WARNING** It is extremely important that a PLC and all PLC Units be used for the specified purpose and under the specified conditions, especially in applications that can directly or indirectly affect human life. You must consult with your OMRON representative before applying a PLC system to the above mentioned applications.

### 3 Safety Precautions

 **WARNING** Never attempt to disassemble any Units while power is being supplied. Doing so may result in serious electrical shock or electrocution.

 **WARNING** Never touch any of the terminals while power is being supplied. Doing so may result in serious electrical shock or electrocution.

### 4 Operating Environment Precautions

Do not operate the control system in the following places.

- Where the PLC is exposed to direct sunlight.
- Where the ambient temperature is below 0°C or over 55°C.
- Where the PLC may be affected by condensation due to radical temperature changes.
- Where the ambient humidity is below 10% or over 90%.
- Where there is any corrosive or inflammable gas.
- Where there is excessive dust, saline air, or metal powder.
- Where the PLC is affected by vibration or shock.
- Where any water, oil, or chemical may splash on the PLC.

-  **Caution** The operating environment of the PLC System can have a large effect on the longevity and reliability of the system. Improper operating environments can lead to malfunction, failure, and other unforeseeable problems with the PLC System. Be sure that the operating environment is within the specified conditions at installation and remains within the specified conditions during the life of the system.

## 5 Application Precautions

Observe the following precautions when using the PROFIBUS-DP Master Units or the PLC.

-  **WARNING** Failure to abide by the following precautions could lead to serious or possibly fatal injury. Always heed these precautions.

- Always ground the system to 100  $\Omega$  or less when installing the system to protect against electrical shock.
- Always turn OFF the power supply to the PLC before attempting any of the following. Performing any of the following with the power supply turned ON may lead to electrical shock:
  - Mounting or removing any Units (e.g., I/O Units, CPU Unit, etc.) or memory cassettes.
  - Assembling any devices or racks.
  - Connecting or disconnecting any cables or wiring.

-  **Caution** Failure to abide by the following precautions could lead to faulty operation of the PLC or the system or could damage the PLC or PLC Units. Always heed these precautions.

- Use the Units only with the power supplies and voltages specified in the operation manuals. Other power supplies and voltages may damage the Units.
- Take measures to stabilise the power supply to conform to the rated supply if it is not stable.
- Provide circuit breakers and other safety measures to provide protection against shorts in external wiring.
- Do not apply voltages exceeding the rated input voltage to Input Units. The Input Units may be destroyed.
- Do not apply voltages exceeding the maximum switching capacity to Output Units. The Output Units may be destroyed.
- Always disconnect the LG terminal when performing withstand voltage tests.
- Install all Units according to instructions in the operation manuals. Improper installation may cause faulty operation.
- Provide proper shielding when installing in the following locations:
  - Locations subject to static electricity or other sources of noise.
  - Locations subject to strong electromagnetic fields.
  - Locations subject to possible exposure to radiation.
  - Locations near power supply lines.
- Be sure to tighten Backplane screws, terminal screws, and cable connector screws securely.
- Do not attempt to take any Units apart, to repair any Units, or to modify any Units in any way.

-  **Caution** The following precautions are necessary to ensure the general safety of the system. Always heed these precautions.

- Provide double safety mechanisms to handle incorrect signals that can be

---

---

generated by broken signal lines or momentary power interruptions.

- Provide external interlock circuits, limit circuits, and other safety circuits in addition to any provided within the PLC to ensure safety.

## **6 EC Directives**

PROFIBUS-DP Master Units that meet EC directives also meet the common emission standard (EN50081-2). When PROFIBUS-DP Master Units are built into equipment, however, the measures necessary to ensure that the standard is met will vary with the overall configuration, the other devices connected, and other conditions. You must therefore confirm that EC directives are met for the overall machine or device.



# 1 PROFIBUS-DP

This section gives a brief description of PROFIBUS-DP.

1-1 Introduction.....	2
1-2 Protocol architecture .....	2
1-3 Device types.....	4
1-4 PROFIBUS-DP characteristics .....	4
1-4-1 Bus Access Protocol .....	4
1-4-2 Data throughput .....	5
1-4-3 Diagnostics functions .....	6
1-4-4 Protection mechanisms.....	6
1-4-5 Network states .....	7
1-5 Device Data Base files .....	8
1-6 Profiles .....	8

## 1-1 Introduction

<b>Multi-vendor</b>	PROFIBUS is a vendor-independent, open fieldbus standard for a wide range of applications in manufacturing, process and building automation. Vendor independence and openness are guaranteed by the PROFIBUS standard EN 50170. With PROFIBUS, devices of different manufacturers can communicate without special interface adjustments. The PROFIBUS family consists of three compatible versions:
<b>Standard EN 50170</b>	
<b>High speed</b>	<b>PROFIBUS-DP</b> <b>DP</b> stands for <b>D</b> ecentralised <b>P</b> eriphery. It is optimised for high speed and low-cost interfacing, especially designed for communication between automation control systems and distributed I/O at the device level.
<b>Process Automation</b>	<b>PROFIBUS-PA</b> <b>PA</b> stands for <b>P</b> rocess <b>A</b> utomation. It permits sensors and actuators to be connected on one common bus line even in intrinsically-safe areas. It permits data communication and power supply over the bus using 2-wire technology according to the international standard IEC 1158-2.
<b>Higher level</b>	<b>PROFIBUS-FMS</b> <b>FMS</b> stands for <b>F</b> ieldbus <b>M</b> essage <b>S</b> pecification. This version is the general-purpose solution for communication tasks at a higher level. Powerful services open up a wide range of applications and provide great flexibility. It can also be used for extensive and complex communications tasks.
<b>Uniform bus access protocol</b>	PROFIBUS-DP and PROFIBUS-FMS use the same transmission technology and a uniform bus access protocol. Thus, both versions can be operated simultaneously on the same cable. However, FMS field devices cannot be controlled by DP masters or vice versa.

**Caution**

It is not possible to exchange one of these family members by another family member. This will cause faulty operation.

The rest of this section only describes PROFIBUS-DP.

## 1-2 Protocol architecture

<b>OSI</b>	The PROFIBUS protocol architecture is oriented on the OSI (Open System Interconnection) reference model in accordance with the international standard ISO 7498. Layer 1 (physical layer) of this model defines the physical transmission characteristics. Layer 2 (data link layer) defines the bus access protocol. Layer 7 (application layer) defines the application functions.
------------	-------------------------------------------------------------------------------------------------------------------------------------------------------------------------------------------------------------------------------------------------------------------------------------------------------------------------------------------------------------------------------------

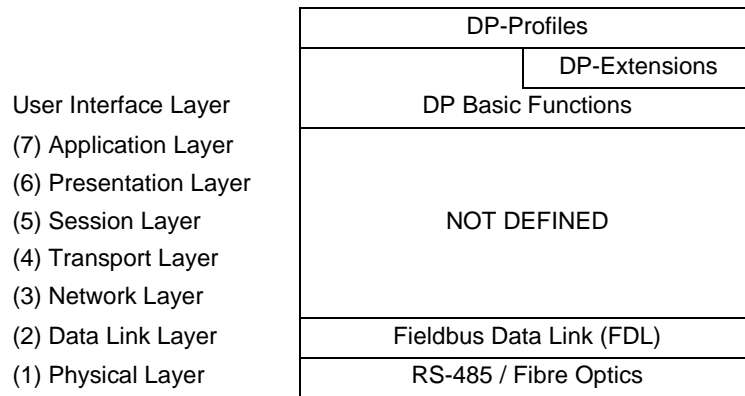

- Layer 1, 2 and user interface** PROFIBUS-DP uses layers 1 and 2, and the user interface. Layers 3 to 7 are not defined. This streamlined architecture ensures fast and efficient data transmission. The application functions which are available to the user, as well as the system and device behaviour of the various PROFIBUS-DP device types, are specified in the user interface. RS-485 transmission technology or fibre optics are available for transmission. RS-485 transmission is the most frequently used transmission technology. Its application area includes all areas in which high transmission speed and simple inexpensive installation are required. Twisted pair shielded copper cable with one conductor pair is used.
- Transmission medium**
- High-speed, inexpensive**
- Easy installation** The RS-485 transmission technology is very easy to handle. Installation of the twisted pair cable does not require expert knowledge. The bus structure permits addition and removal of stations or step-by-step commissioning of the system without influencing the other stations. Later expansions have no effect on stations which are already in operation.  
Transmission speeds between 9.6 kbit/s and 12 Mbit/s can be selected. One unique transmission speed is selected for all devices on the bus when the system is commissioned.
- Cable length** The maximum cable length depends on the transmission speed (see table below). The specified cable lengths are based on type-A cable (see section 2-3-1). The length can be increased by the use of repeaters. The use of more than 3 repeaters in series is not recommended.

Baud rate (kbit/s)	Distance/segment (m)
9.6	1200
19.2	1200
93.75	1200
187.5	1000
500	400
1500	200
3000	100
6000	100
12000	100

## 1-3 Device types

	PROFIBUS distinguishes between master devices and slave devices.
<b>Master devices</b>	Master devices determine the data communication on the bus. A master can send messages without an external request when it holds the bus access rights (the token). Masters are also called active stations in the PROFIBUS protocol.
<b>Active stations DPM1, DPM2</b>	There are two types of master devices: DP master class 1 (DPM1) and DP master class 2 (DPM2). A DPM1 is a central controller which exchanges information with the decentralised stations (i.e. DP slaves) within a specified message cycle. DPM2 devices are programmers, configuration devices or operator panels. They are used during commissioning for configuration of the DP system or for operation and monitoring purposes.
<b>Slave devices</b>	Slave devices are peripheral devices. Typical slave devices include input/output devices, valves, drives and measuring transmitters. They do not have bus access rights and they can only acknowledge received messages or send messages to the master when requested to do so. Slaves are also called passive stations.
<b>Passive stations</b>	The C200HW-PRM21 is a DPM1 device.

## 1-4 PROFIBUS-DP characteristics

### 1-4-1 Bus Access Protocol

<b>Layer 2</b>	The bus access protocol is implemented by layer 2. This protocol also includes data security and the handling of the transmission protocols and telegrams.
<b>Medium Access Control</b>	The Medium Access Control (MAC) specifies the procedure when a station is permitted to transmit data. The token passing procedure is used to handle the bus access between master devices and the polling procedure is used to handle the communication between a master device and its assigned slave device(s).
<b>Token passing</b>	The token passing procedure guarantees that the bus access right (the token) is assigned to each master within a precisely defined time frame. The token message, a special telegram for passing access rights from one master to the next master must be passed around the logical token ring - once to each master - within a specified target rotation time.
<b>Polling procedure</b>	The polling or master-slave procedure permits the master, which currently owns the token, to access the assigned slaves. The picture below shows a possible configuration.

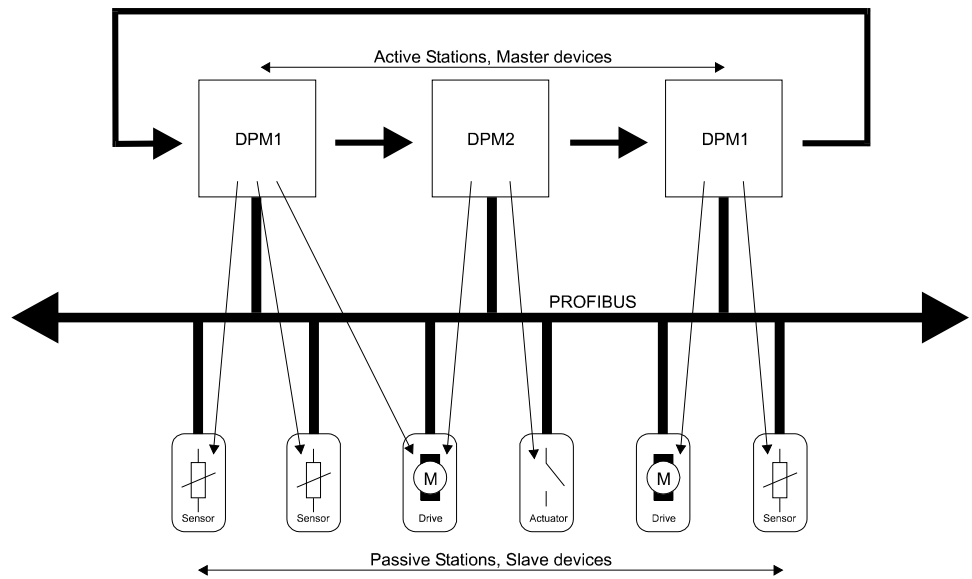

The configuration shows three active stations (masters) and six passive stations (slaves). The three masters form a logical token ring. When an active station receives the token telegram, it can perform its master role for a certain period of time. During this time it can communicate with all assigned slave stations in a master-slave communication relationship and a DPM2 master can communicate with DPM1 master stations in a master-master communication relationship.

**Multi-peer communication**

In addition to logical peer-to-peer data transmission, PROFIBUS-DP provides multi-peer communication (broadcast and multicast).

Broadcast communication: an active station sends an unacknowledged message to all other stations (master and slaves).

Multicast communication: an active station sends an unacknowledged message to a predetermined group of stations (master and slaves).

**1-4-2 Data throughput**

**Transmission time**

At 12 Mbit/s PROFIBUS-DP requires only about 1 ms for the transmission of 512 bits of input data and 512 bits of output data distributed over 32 stations. The figure below shows the typical PROFIBUS-DP transmission time depending on number of stations and transmission speed. The data throughput will decrease when more than one master is used.

Bus cycle time vs number of slaves

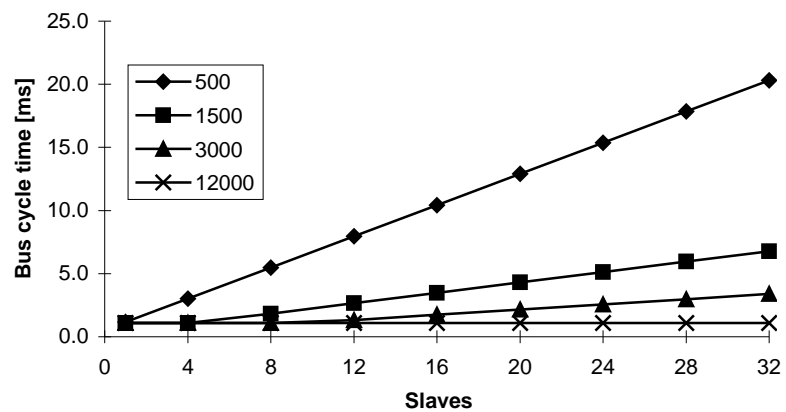

Conditions: Each slave has 2 bytes of input data and 2 bytes of output data.

### 1-4-3 Diagnostics functions

#### Extensive diagnostics

The extensive diagnostic functions of PROFIBUS-DP enable fast location of faults. The diagnostic messages are transmitted over the bus and collected at the master. These messages are divided into three levels:

#### Device related diagnostics

- Device related diagnostics  
These messages concern the general operational status of the whole device (i.e. overtemperature or low voltage).

#### Module related diagnostics

- Module related diagnostics  
These messages indicate that a fault is present in a specific I/O range (e.g. an 8-bit output module) of a station.

#### Channel related diagnostics

- Channel related diagnostics  
These messages indicate an error at an individual input or output (e.g. short circuit on output 5).

### 1-4-4 Protection mechanisms

#### Time monitoring

PROFIBUS-DP provides effective protection functions against parameterisation errors or failure of the transmission equipment. Time monitoring is provided at the DP master and at the DP slaves. The monitoring interval is specified during the configuration.

#### At the master

- Protection mechanism at the master.  
The DPM1 monitors data transmission of the slaves with the Data\_Control\_Timer. A separate control timer is used for each slave. This timer expires when correct data transmission does not occur within the monitoring interval. The user is informed when this happens. If the automatic error reaction (Auto\_clear = TRUE) has been enabled, the DPM1 exits its Operate state, switches the outputs of all assigned slaves to fail-safe status and changes to its Clear status (see also next section).

#### At the slave

- Protection mechanism at the slave.  
The slave uses the watchdog control to detect failures of the master or the transmission line. If no data communication with the master occurs within the watchdog control interval, the slave automatically switches its outputs to the fail-safe status.  
Also, access protection is required for the inputs and outputs of the DP slaves operating in multi-master systems. This ensures that direct access

can only be performed by the authorised master. For all other masters, the slaves offer an image of their inputs and outputs which can be read from any master, even without access rights.

### 1-4-5 Network states

PROFIBUS-DP distinguishes four different states.

- Offline**
  - Offline  
Communication with all DP participants is stopped.
- Stop**
  - Stop  
Communication between DPM1 and DP slaves is stopped. Only communication between DPM1 and DPM2 is possible.
- Clear**
  - Clear  
DPM1 master tries to set parameters, check the configuration, and perform data exchange with its associated DP-slaves. The data exchange comprises reading the inputs of the DP-slaves and writing zero's to the outputs of the DP-slaves.
- Operate**
  - Operate  
DPM1 master exchanges data with its assigned slaves, inputs are read and outputs are written. Beside this, the DPM1 cyclically sends its local status to all assigned DP slaves (with a multicast) at a configurable time interval.
- Auto\_clear**

When an error occurs during the data transfer phase of the DPM1, the 'Auto\_clear' configuration parameter determines the subsequent actions. If this parameter is set to false, the DPM1 remains in the Operate state. If set to true, the DPM1 switches the outputs of all assigned DP slaves to the fail-safe state and the network state changes to the Clear state.
- Fail-safe state**

## 1-5 Device Data Base files

<b>Plug-and-play</b>	To achieve simple plug-and-play configuration of the PROFIBUS-DP network, the characteristic features of a device are specified in a file. This file is called a DDB-file (Device Data Base file) or a GSD-file (Gerätstammdaten file). The GSD files are prepared individually by the vendor for each type of device according a fixed format. Some parameters are mandatory, some have a default value and some are optional.
<b>DDB-file, GSD-file</b>	The device data base file is divided into three parts:
<b>General section</b>	<ul style="list-style-type: none"><li>• General specifications This section contains vendor and device names, hardware and software release states, station type and identification number, protocol specification and which baud rates are supported.</li></ul>
<b>DP-master section</b>	<ul style="list-style-type: none"><li>• DP master-related specifications This section contains all parameters which only apply to DP master devices (i.e. maximum memory size for master parameter set, maximum number of entries in the list of active stations or the maximum number of slaves the master can handle).</li></ul>
<b>DP-slave section</b>	<ul style="list-style-type: none"><li>• DP slave-related specifications This section contains all specification related to slaves (i.e. minimum time between two slave poll cycles, specification of the inputs and outputs and about consistency of the I/O data).</li></ul>
<b>Configurator</b>	<p>The device data base file of each device is loaded in the configurator and downloaded to the master device. The device data base file for the C200HW-PRM21, named OC_1656.GSD, is provided with the configuration software.</p> <p>Section 4 will describe the configurator package SyCon, which is used for configuration of the C200HW-PRM21, in more detail.</p>

## 1-6 Profiles

<b>Exchanging devices</b>	To enable the exchange of devices from different vendors, the user data has to have the same format. The PROFIBUS-DP protocol does not define user data, it is only responsible for the transmission of this data. The format of user data is defined in so called profiles. Profiles may reduce engineering costs since the meaning of application-related parameters is specified precisely. Profiles have for instance been defined for drive technology, encoders, and for sensors / actuators.
---------------------------	-----------------------------------------------------------------------------------------------------------------------------------------------------------------------------------------------------------------------------------------------------------------------------------------------------------------------------------------------------------------------------------------------------------------------------------------------------------------------------------------------------



## 2 Installation

This section describes the installation of the C200HW-PRM21

2-1 Physical layout of the unit .....	10
2-1-1 LEDs.....	10
2-1-2 Rotary Switch .....	10
2-1-3 BUS Connector.....	11
2-1-4 Configurator Connector .....	12
2-1-5 Termination Switch.....	13
2-2 Mounting the C200HW-PRM21 .....	13
2-3 Setting up a network.....	14
2-3-1 Fieldbus cabling .....	14
2-3-2 Configuring the fieldbus.....	16

## 2-1 Physical layout of the unit

The figure below shows the side and front views of the C200HW-PRM21.

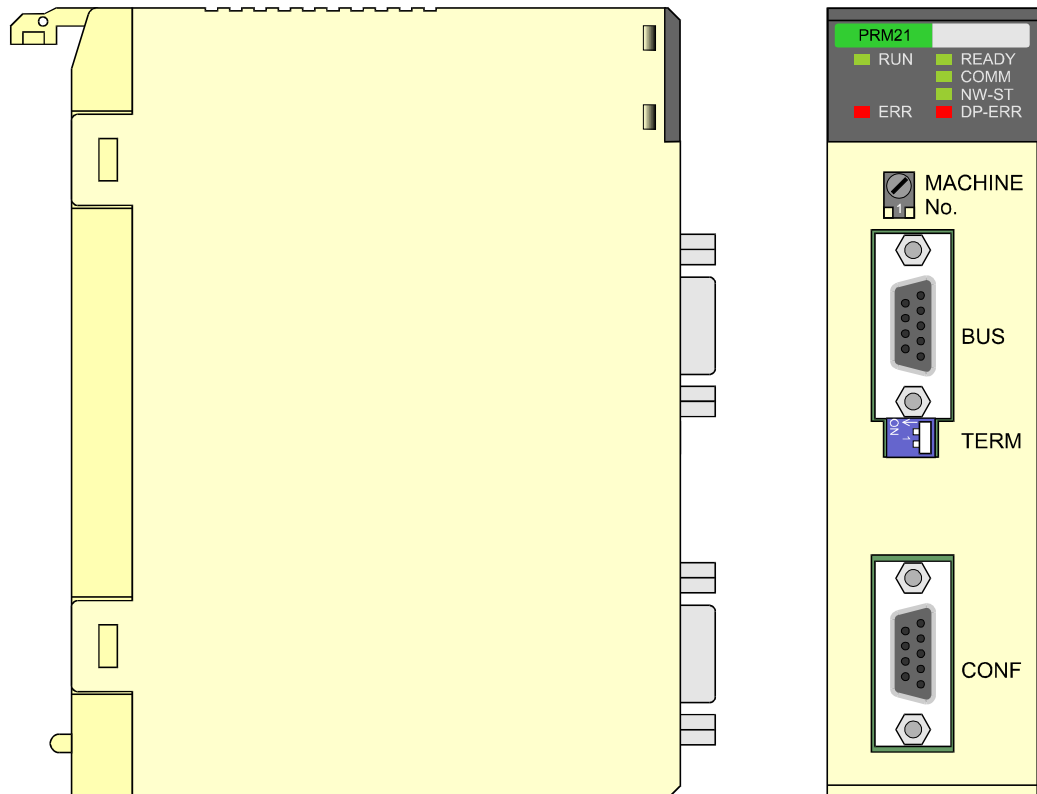

The front view shows the indicator LEDs, the 'Machine No.' rotary switch, two 9-pin female sub-D connectors, and the bus termination switch.

### 2-1-1 LEDs

The C200HW-PRM21 has 6 indicator LEDs. The two LEDs on the left side give a status indication of the unit in general. The four LEDs on the right side are related to the status of the PROFIBUS-DP network. Refer to section 5-4 for a detailed (functional) description of the LEDs.

### 2-1-2 Rotary Switch

The rotary switch is used to set the unit number (or so called "Machine No.").

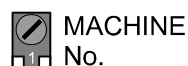

The unit number setting determines which words in the Internal Relay and Data Memory Areas are allocated to the Master Unit.

The allowed unit number setting range depends on the PLC CPU Unit being used, as shown in the following table.

CPU Unit models	Unit number setting range	Setting method
C200HS, C200HE, C200HG-CPU3[ ]-E/CPU4[ ]-E, C200HX-CPU3[ ]-E/CPU4[ ]-E	0 to 9	Single-digit hexadecimal
C200HG-CPU5[ ]-E/CPU6[ ]-E, C200HX-CPU5[ ]-E/CPU6[ ]-E Cs1-series	0 to F	

Any unit number in the setting range is allowed as long as it has not been set on another Special I/O Unit connected to the PLC. If the same unit number is used for the C200HW-PRM21 and another Special I/O Unit, an I/O Unit Over error will occur in the PLC and it will not be possible to start up the PROFIBUS-DP Network.

**Note** Always turn OFF the power to the PLC before changing the unit number setting. The Unit only reads the unit number setting during the initialisation after power-up, so not after a software reset.  
Use a small flat-blade screwdriver to turn the rotary switch; be careful not to damage the switch.

### 2-1-3 BUS Connector

The fieldbus connector is a 9-pin female sub-D connector, as recommended by the PROFIBUS standard EN 50170.

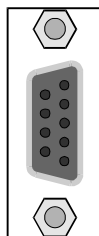

Pin No.	Signal	Description
1	Shield	Shield / protective ground
2	-	-
3	B-line	Data signal
4	RTS	Control signal for repeaters (direction control) (TTL)
5	DGND	Data ground
6	VP	Supply voltage of the terminator resistance (5V)
7	-	-
8	A-line	Data signal
9	-	-

The signals DGND and VP are used internally to power the bus terminator (see section 2-1-5).

The signal RTS (TTL signal) is meant for the direction control of repeaters if repeaters without self control capability are used.

The PROFIBUS standard defines 24 V remote powering signals for pin 2 and pin 7. These signals are optional and have not been implemented in this Unit.

### 2-1-4 Configurator Connector

The configurator connector is a 9-pin female sub-D connector.

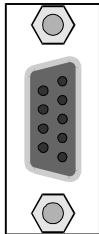

CONF

Pin No.	Signal	Description
1	FG	Frame Ground (shield)
2	SD	Send Data
3	RD	Receive Data
4	RS	Request to Send
5	CS	Clear to Send
6	-	-
7	-	-
8	-	-
9	SG	Signal Ground

The pin assignment of this connector is the same as the that of the RS-232C port provided on most C200H-series CPUs. This enables the use of the same serial communication cable for both the CPU and the C200HW-PRM21.

The wiring of the RS-232C cable is shown in the picture below.

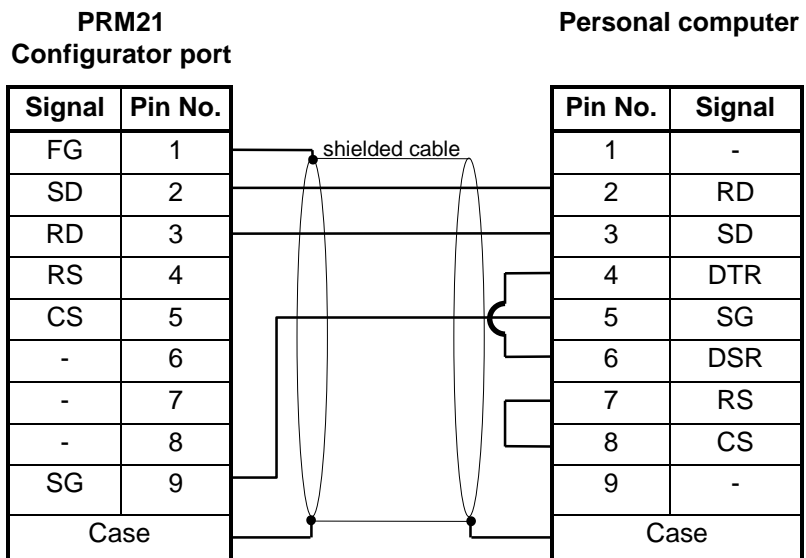

### 2-1-5 Termination Switch

The termination switch has two positions. When the switch is set to the right (as shown below), the termination is disabled. By setting the switch to the left, the termination is enabled.



Enabling the termination connects the two data lines using a 220 Ω resistor which is connected to VP and DGND via two 390 Ω resistors (see figure below). The powering of the terminator resistor ensures a defined idle state potential on the data lines.

To ensure proper functioning up to the highest baud rate, the bus cable has to be terminated on both ends of the cable.

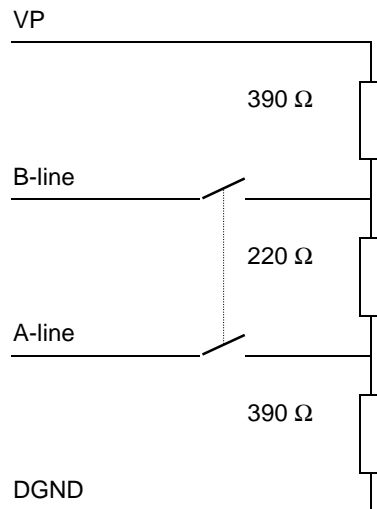

## 2-2 Mounting the C200HW-PRM21

The PROFIBUS-DP Master Unit (C200HW-PRM21) can be mounted to the CPU Rack or Expansion I/O Rack of any CS1, C200HX, -HG, -HE, or -HS PLC. Refer to the PLC's Installation Guide for details on mounting Units.

### Limitations

There are some limitations on mounting the Master Unit.

- The Master Unit is a Special I/O Unit. It can be mounted in any slot in the Backplane of a CPU Rack or Expansion I/O Rack as long as its unit number is not the same as the unit number of another Special I/O Unit within the system.
- The current consumption all of units mounted on one backplane should not exceed the maximum output of the power supply. The C200HW-PRM21 consumes up to 600 mA from the 5V supply. Verify the characteristics of all other units on their respective Instruction Sheets.
- The maximum number of Master Units that can be mounted depends on the PLC CPU type.

CPU Unit models	Max. No. of Master Units
C200HS-CPU[ ] (all models) C200HE-CPU11/32/42 C200HG-CPU33/43 C200HX-CPU34/44	10
C200HG-CPU53/63 C200HX-CPU54/64 CS1-series	16

## 2-3 Setting up a network

### 2-3-1 Fieldbus cabling

#### Bus structure

All devices are connected in a bus structure (i.e. line). Up to 32 stations (master or slaves) can be connected in one segment. The bus must be terminated at the beginning and at the end of each segment. When more than 32 stations are used, repeaters must be used to link the individual bus segments. The maximum number of stations that can be connected to a C200HW-PRM21 is 124.

#### Cable type

The standard EN 50170 specifies to use line type A of shielded twisted pair cables with the following parameters:

Parameter	Value
Impedance	135 to 165 $\Omega$
Capacitance per unit length	< 30 pF/m
Loop resistance	110 $\Omega$ /km
Core diameter	0.64 mm
Core cross section	> 0.34 mm <sup>2</sup>

#### Maximum length

The maximum length of the cable depends on the transmission speed. The cable lengths specified in the table below are based on line type A.

Baud rate (kbit/s)	Distance/segment (m)
9.6, 19.2, 93.75	1200
187.5	1000
500	400
1500	200
3000, 6000, 12000	100

#### Repeaters

The communication distance can be increased by the use of repeaters. It is not recommended to use more than 3 repeaters in series. A repeater also must be included in the count of the number of stations per segment to determine the bus load (so only 31 'normal' devices are possible per segment if a repeater is used)

#### Stub lines

Stub lines should be avoided for data transmission speeds of more than 500 kbit/s. Plug connectors available on the market permit the incoming data cable and the outgoing data cable to be connected directly in the plug connector. This means that stub lines do not have to be used, and the bus plug connector can be connected and disconnected at all times without interrupting data communication with the other stations.

### Fieldbus connector

The connector plug to be used on the C200HW-PRM21 is a 9-pin male sub-D, preferably with a metal case, and a facility to connect the shield of the cable to the case. The cable should at least be connected to pin 3 (B-line) and pin 8 (A-line) of the connector.

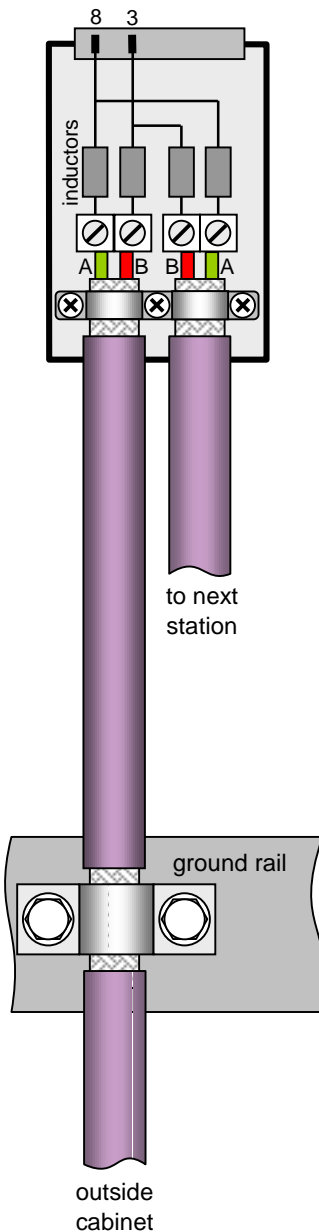

At baud rates of 1.5 Mbit/s or higher, always use special PROFIBUS-DP plugs with built-in series inductances, to ensure that cable reflections caused by the capacitive the load of each unit are minimised.

Connector plugs with built-in inductors, as shown here schematically, are available from various manufacturers.

A standard 9-pin sub-D plug can only be used if the C200HW-PRM21 is at the start or at the end of a bus segment, or on a stub line at baud rates of 500 kbit/s or less.

To ensure electro-magnetic compatibility (EMC), the shield of the cable should be connected to the metal case of the connector. If this is impossible, use pin 1.

If the Unit is installed within a control cabinet, the cable shield of the bus cable should be electrically connected to a grounding rail as close as possible to the cable lead-through using a shield grounding clamp or similar. The cable shield should continue within the cabinet to the fieldbus device.

Ensure that the PLC and the control cabinet in which the device is mounted have the same ground potential by providing a large-area metallic contact to ground (use e.g. galvanised steel to ensure a good connection). Grounding rails should not be attached to painted surfaces.

You may find further information about

- Commissioning of PROFIBUS equipment
- Testing the PROFIBUS cable and bus connectors
- Determining the loop resistance
- Testing for correct bus termination
- Determining the segment length and cable route
- Other test methods
- Example of an equipment report

in the PROFIBUS guideline "Installation Guideline for PROFIBUS-DP/FMS" (PNO Order No- 2.112), which is available at every regional PROFIBUS user organisation.

### 2-3-2 Configuring the fieldbus

#### Configurator

After making the physical connections of the network, the network needs to be configured. For each master and its assigned slaves, a configuration has to be defined using SyCon, a dedicated PC-based configuration program.

The configurator provides the master with information about:

- The slaves that are connected to the master.
- The assignment of slaves to groups for broadcast / multicast messages.
- The mapping of the slaves into the memory of the master.
- The bus parameters (e.g. baud rate, target rotation time etc.).

For more details about the configurator refer to section 4.

#### Downloading configuration

After entering the configuration, it must be downloaded to the master unit. A serial COM-port of the PC is to be connected to the C200HW-PRM21 via the prescribed RS-232C cable.

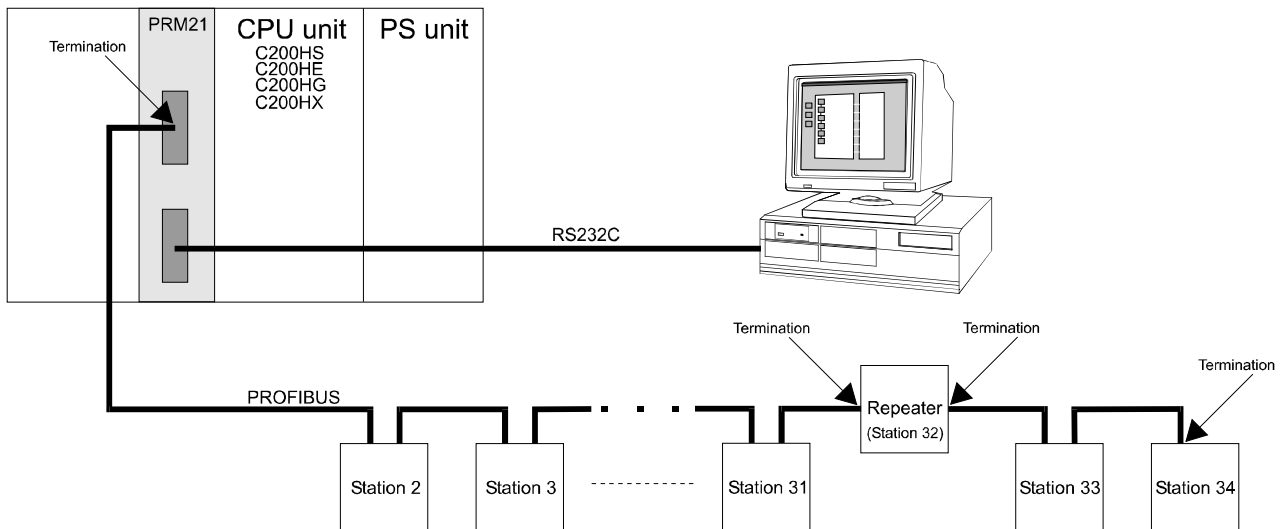



# 3 Specifications and Performance

This section describes the overall specifications and the communication performance of the Unit

- 3-1 Overall Specifications ..... 18
- 3-2 Performance ..... 20
  - 3-2-1 *Fieldbus cycle time* ..... 20
  - 3-2-2 *PLC cycle time* ..... 24
  - 3-2-3 *I/O response time in asynchronous mode* ..... 25
  - 3-2-4 *I/O response time in synchronous mode* ..... 27

## 3-1 Overall Specifications

		C200HS	C200HE/HG/HX, CS1
<b>Model code</b>		C200HW-PRM21	
<b>Maximum. number of Master Units (with user defined I/O mapping)</b>		10	C200HE-CPU11/32/42 C200HG-CPU33/43 C200HX-CPU34/44 10
			C200HG-CPU53/63 C200HX-CPU54/64 CS1-series 16
<b>Master Unit mounting position</b>		CPU Rack or Expansion I/O Rack (classified as Special I/O Unit) Unit cannot be mounted to SYSMAC BUS Slave Racks. Unit cannot be used on a C200H PLC system.	
<b>Settings</b>		Rotary switch : Unit number Toggle switch : Bus termination	
<b>Displays</b>		Unit status : RUN (green LED), ERR (red LED) Network status : READY (green LED), COMM (green LED), NW-ST (green LED), DP-ERR (red LED)	
<b>External connectors</b>		9-pin female sub-D connector (fieldbus connector, RS-485) 9-pin female sub-D connector (configurator connector, RS-232C)	
<b>No. of IR words</b>		2 words of control data out + 3 words of unit status in	
<b>No. of DM settings</b>		18 words of unit setup information	
<b>No. of slave status words</b>		16 words of status + diagnostic bits (location is user definable)	
<b>Remote I/O communications</b>	<b>Max. No. of Slaves per Master Unit</b>	124	
	<b>Max. No. of I/O words per Master Unit</b>	With default DM settings: 32 words in, 32 words out With user defined DM settings: 80 words, in up to 4 areas	With default DM settings: 50 words in, 50 words out With user defined DM settings: 300 words in up to 4 areas; maximum 100 words per area
<b>Message communications</b>		Not supported	via IOWR / IORD instructions
<b>PROFIBUS-DP</b>	<b>Baud rate</b>	9.6 / 19.2 / 93.75 / 187.5 / 500 kbit/s, 1.5 / 3 / 6 / 12 Mbit/s	
	<b>Supported functions</b>	as client : Data_Exchange, Slave_Diag, Set_Prm, Chk_Cfg, Global_Control as server : Get_Master_Diag	
<b>Network configuration</b>		Configurator program (SyCon V.1.5x) for WIN 3.x, WIN 95 and WIN NT	
<b>Current consumption</b>		600 mA at 5 V DC (from PLC power supply)	
<b>Storage temperature</b>		-20 to +75°C	
<b>Operating temperature</b>		0 to +55°C	
<b>Operating humidity</b>		10% to 90% (non-condensing)	
<b>Conformance to EMC- and environmental standards</b>		EN 50081-2 EN 61131-2	
<b>Weight</b>		250 g	

Dimensions

The following diagram shows the dimensions of the Master Unit. Refer to the PLC's Installation Guide for the dimensions of the Unit when it is mounted to the Backplane. (All dimensions are in mm.)

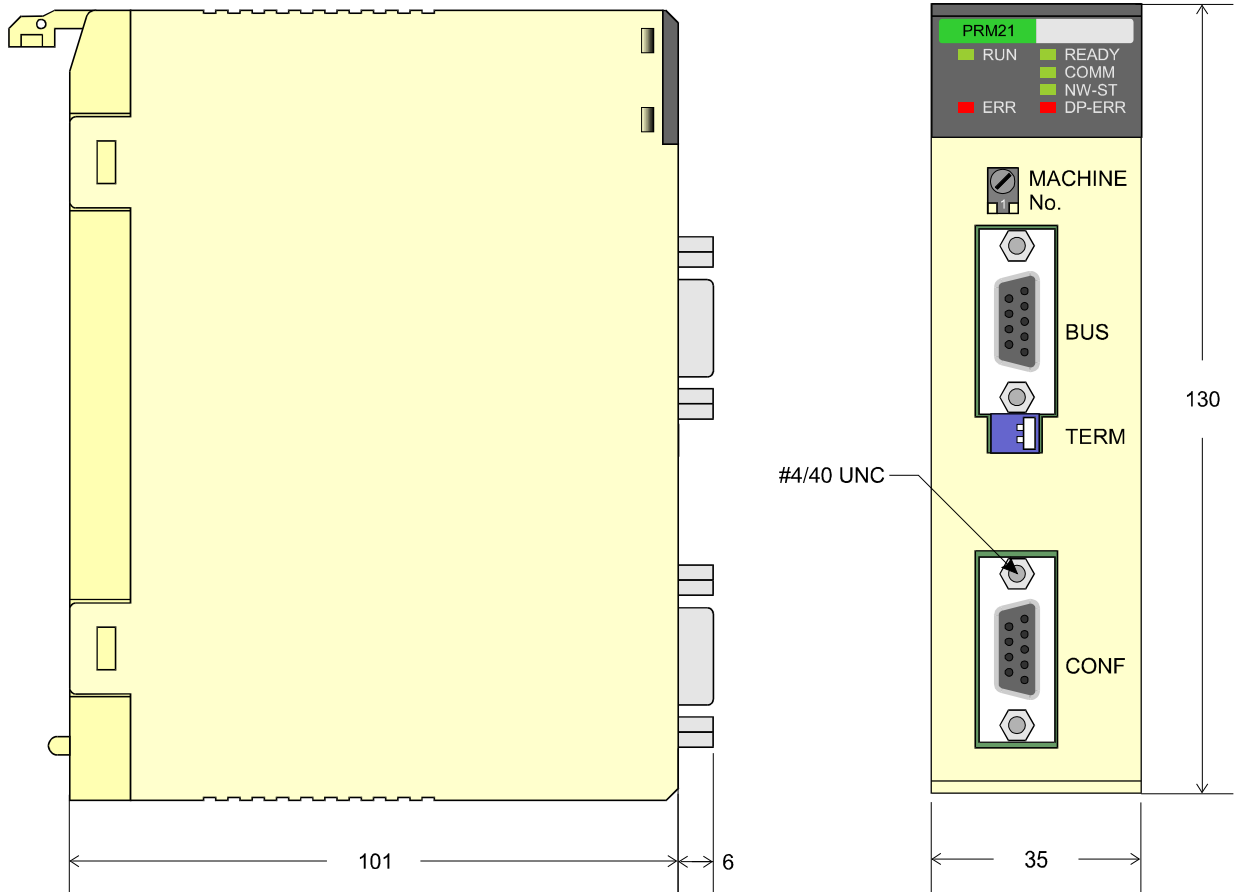

## 3-2 Performance

### 3-2-1 Fieldbus cycle time

This section gives a simplified method of fieldbus cycle time calculations. Refer to EN 50170 for a more detailed calculation of the fieldbus cycle time.

The fieldbus cycle time with only one master is approximately:

$$t_{BC} = (ns + nr) \times t_{MC} + t_{GAP\_REQ} + t_{TC}$$

where: ns = number of slave stations  
 nr = number of message retry cycles  
 $t_{MC}$  = message cycle time  
 $t_{GAP\_REQ}$  = live list check time  
 $t_{TC}$  = token cycle time

The calculation of the fieldbus cycle time for multiple master networks is more complex. For simplicity, extra time needed by each additional master can be said to equal the time it holds the token and passes the token to the next station, plus the time to check for live stations. In this case the fieldbus cycle is approximately:

$$t_{BC} = (ns + nr) \times t_{MC} + nm \times (t_{GAP\_REQ} + t_{TC})$$

where: ns = number of slave stations  
 nr = number of message retry cycles  
 $t_{MC}$  = message cycle time  
 nm = number of master stations  
 $t_{GAP\_REQ}$  = live list check time  
 $t_{TC}$  = token cycle time

For each master station it is possible to specify the target rotation time using the configurator software. If the actual fieldbus cycle time is less than the target rotation time, all messages will be transmitted. If not, the master stations will retain the low priority messages and transmit them at the next or the following token receptions.

**Note** The fieldbus cycle time depends on many variables, not only those mentioned in the formulas above. Therefore the formulas above only give an approximation of the fieldbus cycle time.

The minimum possible fieldbus cycle time equals approximately 1 ms (even if the formula gives a lower value).

The message cycle time, the live list check time, and the token cycle time are explained below.

**Message cycle time**

A message consists of an action frame (request or send/request frame) and a reply frame (acknowledge or response frame). The message cycle time is composed of the frame transmission times, the transmission delay times, the station delay time and the bus idle time.

$$T_{MC} = t_{\text{ACTION-FRAME}} + t_{\text{REPLY-FRAME}} + 2 \times t_{\text{TRANSMIT\_DELAY}} + t_{\text{STATION-DELAY}} + t_{\text{IDLE}}$$

The station delay time is the time the slave needs for decoding the request and generating an acknowledge or response frame.

The bus idle time is the time between an acknowledgement or response of the slave and a new request from the master. Part of this time is used for synchronisation ( $t_{\text{SYN}} = 33 t_{\text{BIT}}$ ).

PROFIBUS has different formats for the action frame and the reply frame. The frames can have a fixed format (with no data field or with a data field of 8 octets) or a variable format (with a variable data field length).

A general formula for the message cycle time:

$$\begin{aligned} t_{MC} &= (9+n1) \times 11 + (9+n2) \times 11 + 2 \times 0 + 30 + 37 t_{\text{BIT}} \\ &= (265 + 11n) t_{\text{BIT}} \end{aligned}$$

where: n1 = number of action data bytes

n2 = number of reply data bytes

n = n1 + n2

The formula is based upon the following assumptions:

- The action frame and response frame have a variable format.
- The transmission delay times are negligible.
- $t_{\text{STATION-DELAY}} = 30 t_{\text{BIT}}$  (typical value for the ASIC SPC3)
- $t_{\text{IDLE}} = 37 t_{\text{BIT}}$

**Live list check time**

Each bus cycle the master requests the FDL (Fieldbus Data Link) status of one of the stations connected to the network, except for the master stations that have been entered in the LAS (List of Active Stations). The stations are checked in sequence.

Each master is designated a certain range of slaves that it has to check. This range is determined by the station addresses of the masters connected to the network and the value for the parameter HSA (Highest Station Address). A master checks the station addresses one higher than his own address up to the next master address. If there is no master with a higher address, the master checks until the value of HSA and starts again with checking from station address 0.

If the station that is being checked is present and functions correctly, the check time is approximately:

$$\begin{aligned} t_{\text{GAP\_REQ}} &= t_{\text{REQ\_FRAME}} + t_{\text{RES\_FRAME}} + 2 \times t_{\text{TRANSMIT\_DELAY}} + t_{\text{STATION-DELAY}} + t_{\text{IDLE}} \\ &= 6 \times 11 + 6 \times 11 + 2 \times 0 + 30 + 37 t_{\text{BIT}} \\ &= 200 t_{\text{BIT}} \end{aligned}$$

If the station is not present, the master stops waiting for an answer after the slot-time (one of the bus parameters). The check time in this case is:

$$\begin{aligned} t_{\text{GAP\_REQ}} &= t_{\text{REQ\_FRAME}} + t_{\text{SLOT}} + t_{\text{IDLE}} \\ &= 6 \times 11 + 100 + 37 t_{\text{BIT}} \\ &= 203 t_{\text{BIT}} \end{aligned}$$

The formulas are based upon the following assumptions:

- The transmission delay times are negligible.
- $t_{\text{STATION-DELAY}} = 30 t_{\text{BIT}}$  (typical value for the ASIC SPC3)
- $t_{\text{IDLE}} = 37 t_{\text{BIT}}$
- $t_{\text{SLOT}} = 100 t_{\text{BIT}}$  (configurable)

### Token cycle time

The token cycle time is the time each master station requires to process and transfer the token. It is composed of the token frame time, the transmission delay time and the bus idle time.

$$t_{\text{TC}} = t_{\text{TOKEN-FRAME}} + t_{\text{TRANSMIT\_DELAY}} + t_{\text{IDLE}}$$

The bus idle time contains the station delay time of the receiver and the synchronisation time.

A general formula for the token cycle time:

$$\begin{aligned} t_{\text{TC}} &= 3 \times 11 + 0 + 37 t_{\text{BIT}} \\ &= 70 t_{\text{BIT}} \end{aligned}$$

The formula is based upon the following assumptions:

- The transmission delay time is negligible.
- $t_{\text{IDLE}} = 37 t_{\text{BIT}}$

### Examples

The two figures below give an indication of the fieldbus cycle time. In each figure the bus cycle time is calculated for four different baud rates (500 kbit/s, 1500 kbit/s, 3000 kbit/s, and 12000 kbit/s).

The first figure shows the effect of the number of slaves on the bus cycle time. The values of the parameters are:

n	= 4 (number of data bytes per slave)
ns	= variable on the x-axis
nr	= 0
Baud rate	= variable per curve

The fieldbus cycle time is calculated with the formula for a single master system.

The bus cycle time increases when the number of slaves increases due to the fact that the total number of data bytes that needs to be transferred increases.

Bus cycle time vs number of slaves

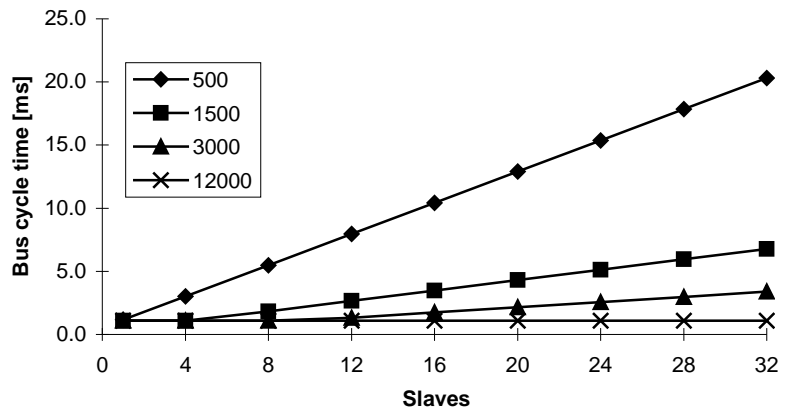

The second figure shows the effect of the number of masters on the bus cycle time. The values of the parameters are:

- n = 4
- ns = nm (each master has one slave)
- nm = variable on the x-axis
- nr = 0
- Baud rate = variable per curve

Bus cycle time vs number of masters

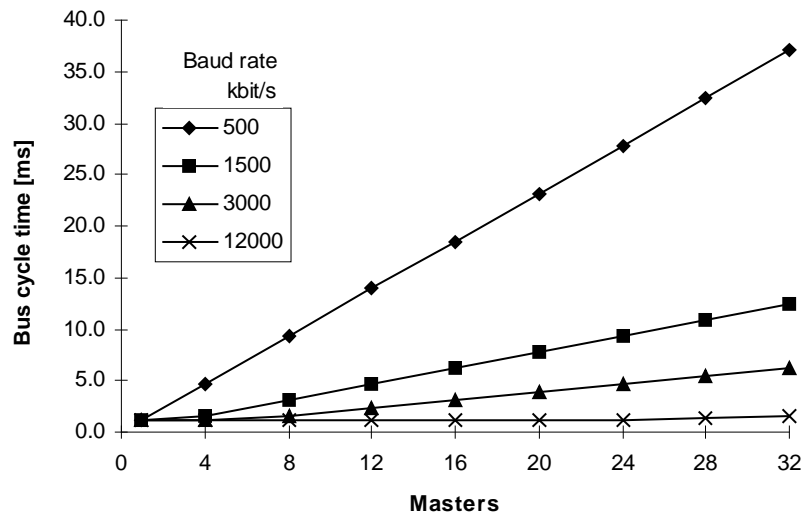

This figure resembles the first figure. An increase of the number of masters also increases the number of slaves and thus increases the number of data bytes that needs to be transferred. The only difference is the addition of the time to pass the token from one master to the other master and the total time on checking the stations is increased. This is an addition of about  $270 t_{BIT}$  per additional master.

### 3-2-2 PLC cycle time

The PLC cycle time mainly depends on the size of the PLC program and the I/O refresh time of the units.

The size of the PLC program is application specific. Besides optimising the PLC program, the program execution time can only be decreased by using a faster CPU.

The total I/O refresh time depends on the types of units that are mounted on the Backplane(s). Not all units refresh the same amount of data.

The I/O refresh time of the C200HW-PRM21 depends on the number of data areas and the number of I/O data words that have been mapped.

The I/O refresh time of the C200HW-PRM21 Unit can be calculated with the following formulas.

C200HS:

$$t_{\text{ORF}} = 1.6 + 0.4 \times na + 0.067 \times nw \text{ [ms]}$$

C200HE, C200HG, C200HX, CS1:

$$t_{\text{ORF}} = 1.0 + 0.4 \times na + 0.018 \times nw \text{ [ms]}$$

where: na = number of mapped data areas  
nw = number of mapped I/O words (na ≥ 1)

Using the default mapping mode, the I/O refresh time is:

C200HS : 6.7 ms (2 areas: 32 words out, 32 words in)

C200HE,  
C200HG,  
C200HX,  
CS1-series : 3.6 ms (2 areas: 50 words out, 50 words in)

Refer to the Operation Manual of the CPU for more detailed calculations of the PLC cycle time.

**Note** The I/O refresh time is not constant over all PLC cycles. During an I/O refresh, the unit can transfer I/O data, slave status information, and IR words (control & status). IR data is always transferred. I/O data and slave status data are only transferred under certain conditions:

Input data: Only when there is new input data available. The situation that there is no new input data occurs when the fieldbus cycle time is greater than the PLC cycle time or when the communication is inhibited.

Output data: Always transferred after the Unit is initialised, except during a download and in the synchronous mode when the fieldbus cycle time is greater than the PLC cycle time.

Slave Status: Always transferred after the Unit is initialised.



### 3-2-3 I/O response time in asynchronous mode

In asynchronous data transfer mode, the fieldbus cycle is not synchronised with the PLC cycle; fieldbus cycles are triggered continuously, independent of the PLC cycle.

**Minimum I/O response time** The figure below shows the minimum I/O response time in asynchronous mode. The figure shows the timing at the PLC, the timing at the Master Unit, the timing at the slave input and the timing at the slave output.

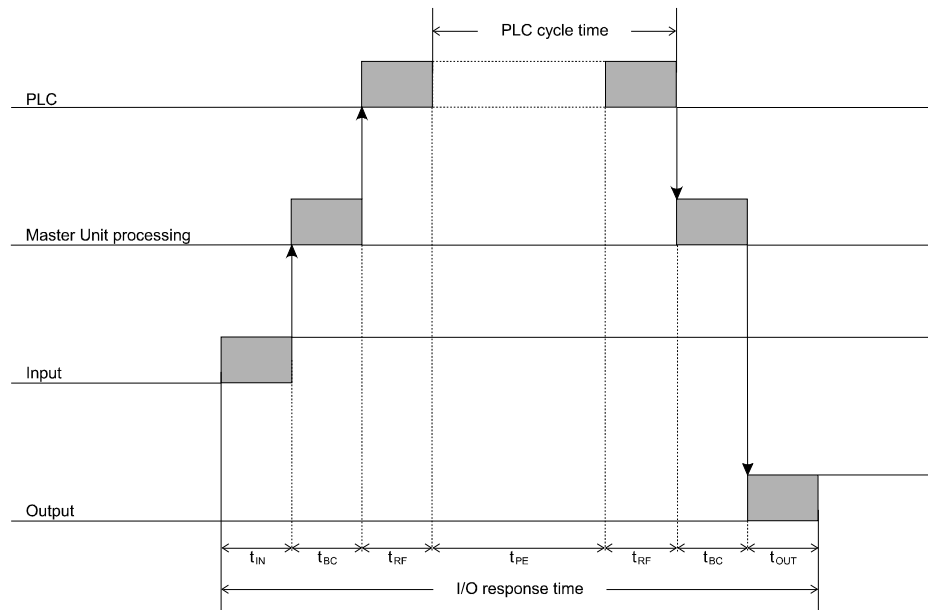

- $t_{IN}$  : The Input Slave's ON (OFF) delay
- $t_{OUT}$  : The Output Slave's ON (OFF) delay
- $t_{BC}$  : The fieldbus cycle time
- $t_{RF}$  : The I/O refresh time
- $t_{PE}$  : Program Execution time

#### Conditions

The minimum response time can be achieved under the following conditions:

1. No other master is connected to the network. More masters will increase the fieldbus cycle time due to the token rotation between masters.
2. User defined I/O data mapping. Only map the input and output data of the configured slaves. This will minimise the number of words that needs to be transferred per PLC cycle and therefore the I/O refresh time.
3. The fieldbus baud rate is set to the highest value allowed for the attached slaves and the used cable length.
4. The IORF instruction can be used to further decrease processing time in the PLC program.

The minimum I/O response time that can be achieved with C200HE, -HG or -HX and the CS1-series is approximately

$$9 \text{ ms} + t_{IN} + t_{OUT}$$

**Maximum I/O response time** The figure below shows the maximum I/O response time in asynchronous mode. The figure shows the timing at the PLC, the timing at the Master Unit, the timing at the slave input and the timing at the slave output.

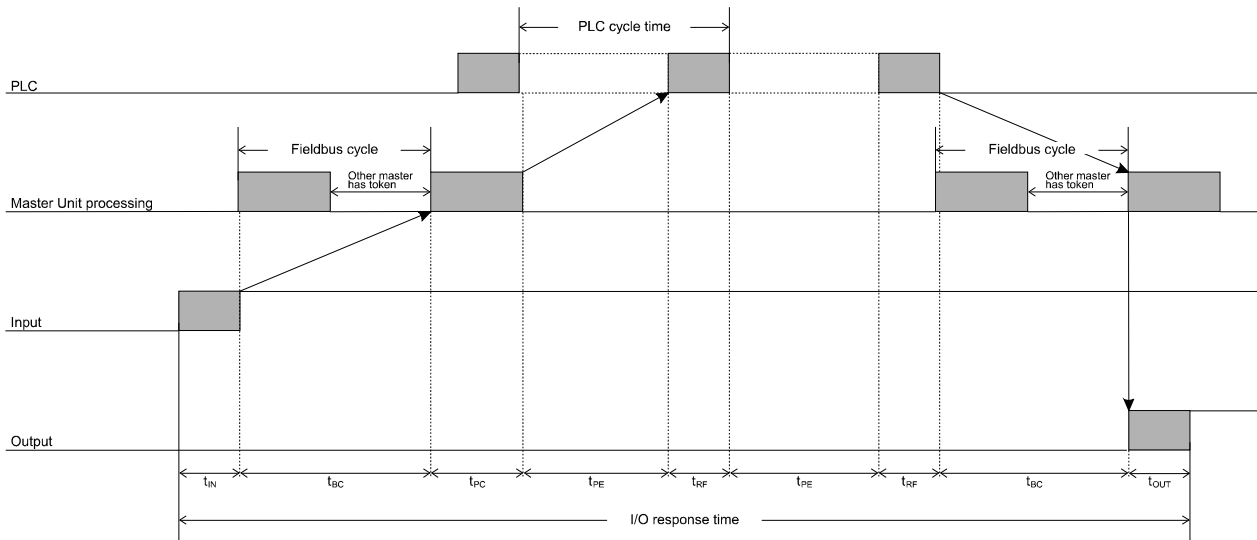

- $t_{IN}$  : The Input Slave's ON (OFF) delay
- $t_{OUT}$  : The Output Slave's ON (OFF) delay
- $t_{BC}$  : The Fieldbus cycle time
- $t_{PC}$  : The Poll cycle time of the respective master
- $t_{RF}$  : The I/O refresh time
- $t_{PE}$  : The Program Execution time

The maximum response time can occur under the following conditions.

1. The slave in question is polled by the respective master at the beginning of the poll cycle.
2. The Input data is available just after the master polled the respective slave.
3. The Master Unit finished processing just after the I/O refresh. The Input data is not transferred to the PLC until the next PLC cycle.
4. A fieldbus cycle just started before the end of the I/O refresh, the output data is not transferred until the next fieldbus cycle.

The I/O response time in the case above is:

$$t_{RESPONSE} = t_{IN} + 2 \times t_{BC} + t_{PC} + 2 \times t_{RF} + 2 \times t_{PE} + t_{OUT}$$

**Note:** With  $t_{PC}$  is meant the time the master of the respective slave needs to poll all slaves that have been assigned to this master.

### 3-2-4 I/O response time in synchronous mode

In synchronous data transfer mode, the fieldbus cycle is triggered immediately following the I/O refresh of the PLC. If the fieldbus cycle has not finished before the start of the I/O refresh, the fieldbus cycle is not triggered until after the next I/O refresh.

**Minimum I/O response time** The figure below shows the minimum I/O response time in synchronous mode. The figure shows the timing at the PLC, the timing at the Master Unit, the timing at the slave input and the timing at the slave output.

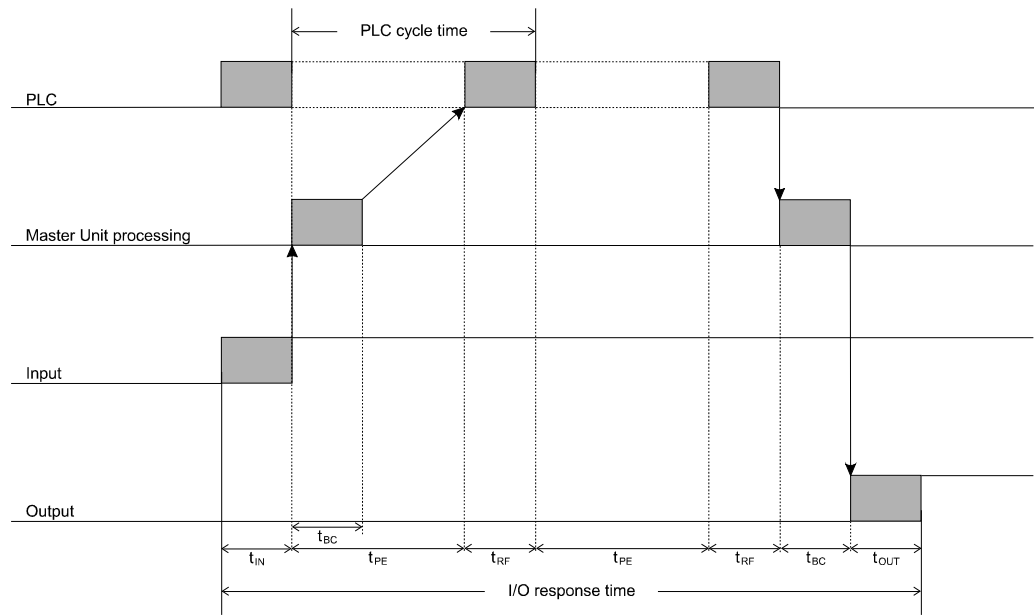

- $t_{IN}$  : The Input Slave's ON (OFF) delay
- $t_{OUT}$  : The Output Slave's ON (OFF) delay
- $t_{BC}$  : The fieldbus cycle time
- $t_{RF}$  : The I/O refresh time
- $t_{PE}$  : Program Execution time

The minimum response time can be achieved under the following conditions:

1. No other master is connected to the network. More masters will increase the fieldbus cycle time due to the token rotation between masters.
2. User defined I/O data mapping. Only map the input and output data of the slave. This will minimise the number of words that needs to be transferred per I/O refresh and therefore minimise the I/O refresh time.
3. PLC cycle time is greater than the fieldbus cycle time. In this case it is guaranteed that one fieldbus can be triggered per PLC cycle.
4. The fieldbus baud rate is set to the highest value allowed for the attached slaves and used cable length.
5. The IORF instruction can be used to further decrease processing time in the PLC program.

The minimum I/O response time that can be achieved with C200HE, -HG or -HX and the CS1-series is approximately

$$8 \text{ ms} + t_{IN} + t_{OUT}$$

**Maximum I/O response time** The figure below shows the maximum I/O response time in synchronous mode. The figure shows the timing at the PLC, the timing at the Master Unit, the timing at the slave input and the timing at the slave output.

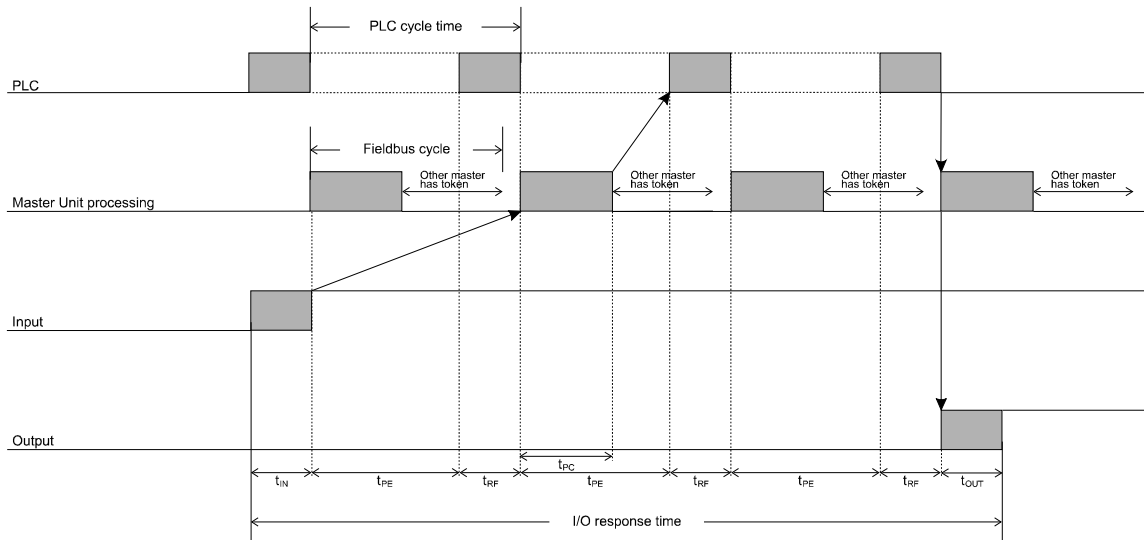

- $t_{IN}$  : The Input Slave's ON (OFF) delay
- $t_{OUT}$  : The Output Slave's ON (OFF) delay
- $t_{PC}$  : The Poll cycle time of the respective master
- $t_{RF}$  : The I/O refresh time
- $t_{PE}$  : The Program Execution time

The maximum response time can occur under the following conditions.

1. The slave in question is polled by the respective master at the beginning of the poll cycle.
2. The poll cycle time of the respective master is less than the program execution time of the PLC program.
3. The Input data is available just after the master polled the respective slave.

The I/O response time in the case above is:

$$t_{RESPONSE} = t_{IN} + 3 \times t_{PE} + 3 \times t_{RF} + t_{OUT}$$

Note: With  $t_{PC}$  is meant the time that the master of the respective slave needs to poll all slaves that have been assigned to this master.

# 4 Configurator

This section describes the configuration software package, required to set up a PROFIBUS-DP network

4-1	General .....	30
4-1-1	Introduction .....	30
4-1-2	System Requirements .....	30
4-2	Setup .....	31
4-2-1	Installation .....	31
4-2-2	Uninstall .....	31
4-3	Operation .....	32
4-3-1	PROFIBUS-DP configuration .....	33
4-3-2	Device database .....	33
4-3-3	Bus configuration .....	34
4-3-4	Device configuration .....	36
4-3-5	Group membership .....	39
4-3-6	Check I/O assignments .....	40
4-3-7	Bus parameters .....	42
4-3-8	Download .....	44
4-4	Debug mode .....	46
4-4-1	Master Diagnostics .....	47
4-4-2	Slave Diagnostics .....	48
4-4-3	Extended diagnostics .....	49

## 4-1 General

To define the network topology and PROFIBUS-DP system characteristics, the C200HW-PRM21 needs to be provided with information about the slave units connected to the network, and basic communication parameters.

### SyCon

This information is entered in the Unit by means of the configuration software package SyCon (V.1.5 or higher). It is not possible to use other (general-purpose) PROFIBUS-DP configuration software packages available from 3<sup>rd</sup> parties.

### 4-1-1 Introduction

The configuration software package for the C200HW-PRM21 PROFIBUS-DP master is used to define:

- The configuration of the bus system connected to the C200HW-PRM21.
- Configuration- and parameter data of all connected slave stations.
- Overall bus communication settings.

All configuration data can be prepared offline. A serial communication link with the C200HW-PRM21 is only necessary to download the configuration file to the Unit, and for debugging purposes.

After the initial configuration has been downloaded, the software package can be used for:

- Addition / deletion of slave units or -modules.
- Monitoring the PROFIBUS system status.
- Troubleshooting communication problems.

It is not possible to set up the C200HW-PRM21 without this configuration software. Once the configuration data has been downloaded into the Unit, the software package is no longer required during normal operation.

### 4-1-2 System Requirements

The following are the minimum requirements for a PC to install the PROFIBUS-DP configurator SyCon V2.620.

Processor:	486DX50 or higher
Operating System:	Windows 95/98 Windows NT 3.51 Windows NT 4.0
RAM:	16 MB or more
Hard disk space:	10 MB minimum
Graphics:	800x600x256 minimum
Serial port:	RS-232C; COM1 to COM4 supported
Communication cable	see 2-3-1 <i>Fieldbus cabling</i>

## 4-2 Setup

### 4-2-1 Installation

The PROFIBUS-DP configurator SyCon V2.620 is supplied on CD-ROM. For installation instructions, see the file README.TXT on the CD-ROM. For installation under Windows NT, administrator rights are required.

Since SyCon V2.620 serves as PROFIBUS-DP configurator for Master devices of several manufacturers, it is necessary to make the correct choices during installation to provide the correct settings for the C200HW-PRM21:

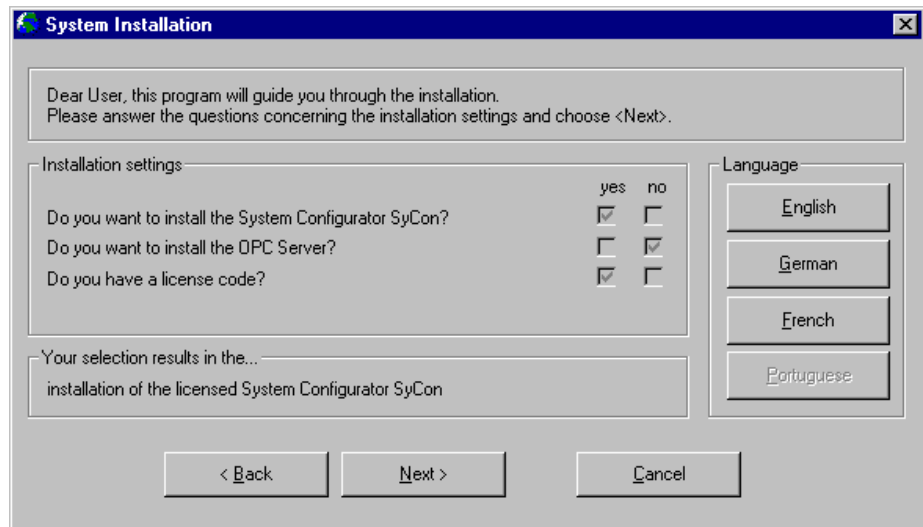

The license code is will be provided on the next installation screen.

When prompted, select to install the PROFIBUS component as well as the CIF device driver.

### 4-2-2 Uninstall

SyCon V2.620 can be removed from your system by:

- selecting 'SyCon Uninstall' from the start menu, or
- through 'Add/remove Programs' in Control Panel.

## 4-3 Operation

### Menu

The operation of the configurator is menu-driven.

The functions located under the main menu items are:

- File**
  - Create, load and save PROFIBUS-DP configuration files.
  - Print configuration data.
  - Copy GSD files to the device database folder.
  - Exit the configurator.
- Edit**
  - Delete items from the configuration.
- View**
  - List all configured devices, sorted by address or by memory allocation.
- Insert**
  - Add Masters and Slaves to the configuration
- Online**
  - Download the configuration to the Unit.
  - Enter the online debug mode.
  - Monitor the status of the network.
- Settings**
  - Select serial communication port.
  - Set overall bus system and communication parameters.
  - Define group assignments for global control commands.
  - Enter general project information.
  - Select the display language (English, French, German)
- Tools**
  - View the main data of PROFIBUS-DP GSD files.
- Window**
  - Arrange and select all open configuration windows.
- Help**
  - Access the help files
  - Display version information.



### 4-3-1 PROFIBUS-DP configuration

To build a PROFIBUS-DP configuration in a reliable and efficient way, adhere to the following sequence of actions:

1, 2, 3...

1. Copy the GSD files of all stations into the assigned folder.
2. Define the master unit, and assign a bus address to it.
3. Define the bus configuration by adding stations to the bus, assigning addresses to the stations, and configuring each device as required.
4. Define the assignment of each slave's in- and output data to the internal buffers of the Unit (or use the master's auto-addressing function).
5. Configure the parameters of all slaves and slave modules as required.
6. Define the overall system- and communication bus parameters.
7. Save the configuration file to disk.
8. Select the serial communication port (Device Assignment)
9. Download the configuration into the Master Unit.
10. Select debug mode to verify the correct operation of the network.

### 4-3-2 Device database

#### GSD files

Each PROFIBUS-DP device, master or slave, is characterised by its Device Database file, also known as GSD file (from German 'Geräte StammDaten'). The GSD file contains information about a device's functionality and characteristics, which need to be known during the configuration of a PROFIBUS-DP network.

The GSD file for the C200HW-PRM21 is named OC\_1656.GSD, and is provided with the configurator software package (see also Appendix B). For each slave that needs to be configured, a specific GSD file must be provided by the manufacturer of the device. Without the GSD file, a slave cannot be configured.

#### Images

The GSD files may refer to bitmap files (\*.DIB, 70x40 pixels x 16 colours) which can be used by the configurator to display the status of the device. If not found, a default image will be displayed.

#### Languages

GSD files may be available from the slave device manufacturer in several languages. The file extension indicates the language used for module type names, parameter options and diagnostic messages:

*.GSD = Default	*.GSF = French
*.GSE = English	*.GSI = Italian
*.GSG = German	*.GSS = Spanish
*.GSP = Portuguese	

#### Device Database Folder

All GSD files to be used in a project need to be available in a specific folder. By default this folder will be:

<install path>\HMS\SyCon\Fieldbus\Profibus\GSD

It is possible to change the location via the menu item 'Settings – Path...'. GSD files can be added to the folder,

- through the menu item 'File – Copy GSD'. SyCon will update its internal device database automatically.
- by regular Windows file copy functions. SyCon needs to be (re-)started after copying the GSD files into the assigned folder, in order to update its device database.



**Caution**

Make sure that all GSD files are available in the assigned folder before opening an existing configuration file.

### 4-3-3 Bus configuration

#### Master selection

The first step to build a configure a Master Unit is to open a blank sheet through the menu item 'File – New', or the icon



Add the Master unit to be configured using 'Insert – Master' or the icon



Position the cursor to a line on the blank sheet, preferably at the top left, and click to insert a Master Unit. A list of masters whose GSD files are found in the Device Database folder is shown.

Select the C200HW-PRM21 from the list of available masters, and click the 'Add>>' button:

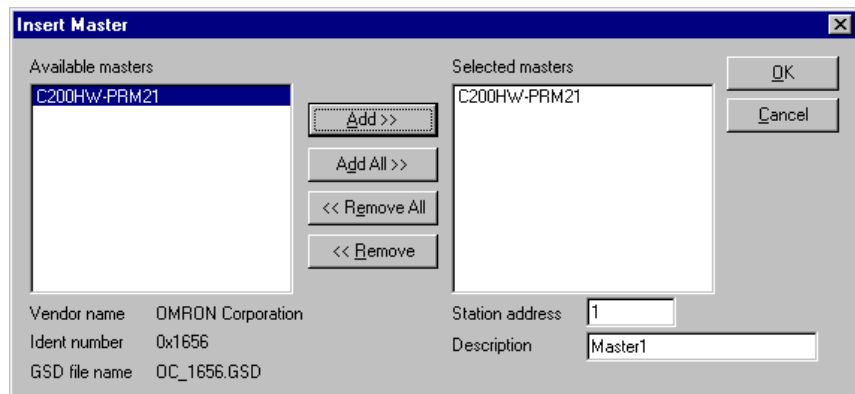

Selecting the added Unit from the list 'Selected Masters' allows you to set its bus address before clicking 'OK'.

#### Multiple Masters

It is possible to add multiple masters to a PROFIBUS-DP configuration. However, each slave can only exchange data with a specific master, and data exchange between masters is not possible.

The presence of multiple masters in one system will however affect the overall bus parameter settings, and building a single configuration will help to keep overview over which slave addresses are assigned to which master.

If multiple masters are defined in one configuration, always pay attention as to which master subsequently inserted slaves are being assigned. Modifying the assignment of slaves in a later stage may affect the mapping of other slaves' I/O data to the Master's I/O buffers.

**Slave selection**

After assigning the Master, the corresponding slaves can be added.  
To add a slave, select 'Insert – Slave', or click the icon:



and select a row in the configuration window. If a unit is already on the selected row, a new row will be inserted above it. The method of insertion is the same as for master units. Multiple slaves can be inserted at a time.

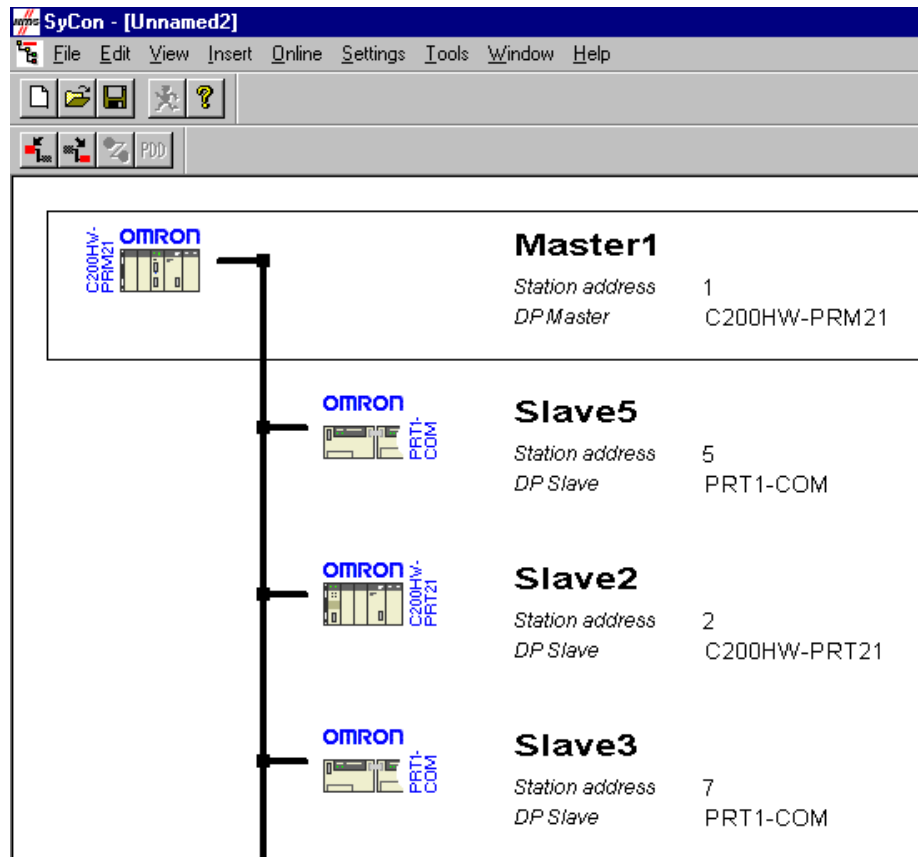

**Address sequence**

Station addresses may be assigned in any sequence, and do not need to be consecutive. The sequence displayed on the screen does not have to represent the physical bus layout.

### 4-3-4 Device configuration

Device configuration comprises the following steps:

1, 2, 3...

- Station address assignment.
- Slave module configuration.
- Mapping of the slaves' I/O data to the Unit's buffer areas.
- Setting the slaves' User Parameter Data.

#### Auto-addressing

The configurator offers the option to automatically assign the I/O data of each slave to a location in the Unit's buffer areas. This feature is turned ON by default, and can be turned OFF via the menu item 'Settings – Master Configuration' (select the Master Unit first), or by double-clicking the Master Unit.

#### Address assignment

Station addresses will be assigned automatically according to sequence of entry. Any automatically assigned address can be changed manually in the Slave Configuration panel.

#### Slave Configuration

To configure a slave, select 'Settings – Slave Configuration', or double-click on its icon in the PROFIBUS-DP window to bring up the following dialog box:

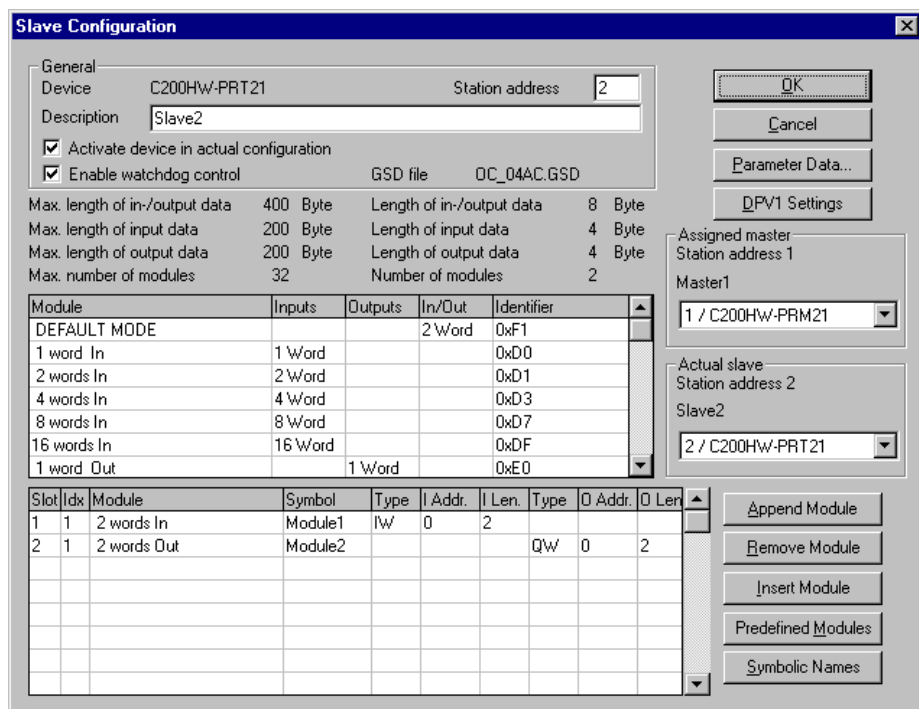

The station address can be changed by typing over the existing one, and each slave can be assigned a symbolic name in the 'Description' field..

The check-box 'Activate device...' can be unchecked if the slave is not yet available in the network, but address space needs to be reserved to add it later.

When the 'Enable watchdog control' item is checked, the slave will perform a specific action when bus communication is disrupted (depends on available functionality in the slave, e.g. output hold, output clear). The actual watchdog time is specified in the bus parameters. It is recommended to keep this function enabled.

From the Slave Configuration panel, all other slaves can be accessed by selecting them from the 'Actual slave' drop-down box.

The items 'DPV1 Settings', 'Predefined Modules' and 'Symbolic Names' are not applicable to the C200HW-PRM21.

**I/O configuration**

If a predefined I/O configuration is made in the GSD file, this will be entered in the module list automatically, and no further modules can be added.

In case of user-configurable modular slaves, select the required modules from the list, either by double clicking, or using the buttons 'Append Module' or 'Insert Module'.

For further configuration of the slave, a button provides access to the parameter data entry panel.

**Auto-addressing**

When Auto-addressing is enabled (through Settings – Master Configuration), no further configuration of the I/O data assignment is required. The allocation of the slave's I/O data to the Master's I/O buffers will be made automatically before downloading the configuration to the Unit, or when viewing the address table.

When Auto-addressing is disabled, the user must make sure that each slave is allocated a sufficiently large area of the Unit's buffers. When a slave's I/O data is found to be overlapping with another slave, an error message will be generated when attempting to download. It is allowed to create gaps in the slave's allocations to the buffers, to anticipate an extension of the network in a later stage. This will however result in a less than optimal data transfer between the Unit and the PLC CPU.

**I/O data allocation**

The 'Type' indicator of each module denotes the slave module's data format:

- IB** for byte inputs                      **QB** for byte outputs
- IW** for word inputs                      **QW** for word outputs

and the lengths of each module's input and output data are listed under the headings 'I Len.' and 'O Len.', respectively.

The locations of each modules' I/O data in the buffers of the Master Unit can be adapted by the user, specifying an offset in Words under 'I Addr.' and 'O Addr.'.

Manually entered offset assignments are automatically checked before being downloaded into the C200HW-PRM21. See 4-3-8, 'Download'.

The example below shows:

- One module (Slot=1) which has two indexed sub-modules (Idx=1, Idx=2)
- Submodule 1-1 has:
  - 1 input word, starting at word 11 of the input buffer
  - 1 output word, starting at word 9 of the output buffer
- Submodule 1-2 has:
  - 16 input bytes, starting at word 12 of the input buffer
  - 4 output bytes, starting at word 10 of the output buffer

Slot	Idx	Module	Symbol	Type	I Addr.	I Len.	Type	O Addr.	O Len.
1	1	O:CISp	Module1	I'W'	11	1	Q'W'	9	1
1	2	O:CISp	Module1	IB	12	16	QB	10	4

**Slave Parameter Data**

Depending on the type of slave, specific parameter information may need to be transferred to the slave at initialisation. The 'Parameter Data' dialog box allows verification and adjustment of these parameters in several ways.

The initial dialog shows all parameter data in hexadecimal notation. A thorough understanding of the device is required to modify the parameters through this panel in a safe way. When in doubt, leave these values at the defaults, which SyCon reads from the GSD file.

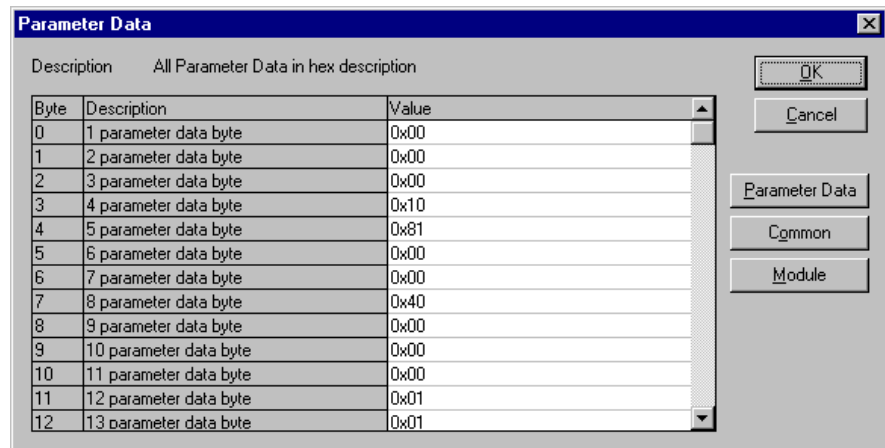

If the GSD file provides additional information for parameter adjustment, the buttons 'Common' and/or 'Module' will be accessible.

'Common' provides access to the parameters which control the slave as a whole, i.e. which are not specific for a module.

'Module' will allow the parameters for a specific module to be adjusted, e.g.

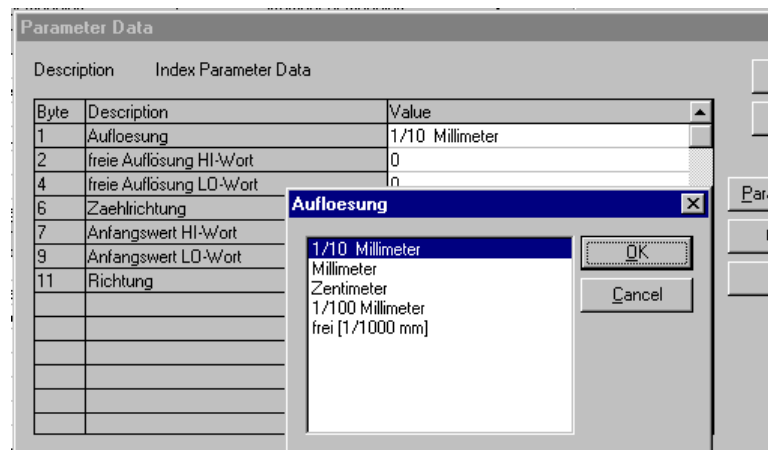

In the example shown, all German texts have been read from the device's GSD file. Please check with the slave manufacturer for the availability of files in other languages.

All module assignments and parameter settings will be saved in the configuration file, and need to be downloaded to the Master Unit. After the download the Master will restart the network, and transfer the settings to the slaves. The configuration and parameter settings cannot be changed online, while the master is in data exchange mode.

### 4-3-5 Group membership

#### Group Definitions

Via the menu item 'Settings – Group membership', up to 8 groups of slaves can be defined as targets for PROFIBUS-DP Global Control Commands.

The Group Membership dialog box allows definition of group names, and of supported functions (Freeze / Sync) per group, For more information on the execution of Freeze / Sync functions, see 5-3-1, *Control words*'.

Group names can be modified for easier identification. This has no effect on the operation of the unit.

The 'Freeze' and 'Sync' check-boxes can be used to prevent assignment of slaves which do not support these functions. Unchecking a function for a specific group will not prevent the processing of the global control command for that group.

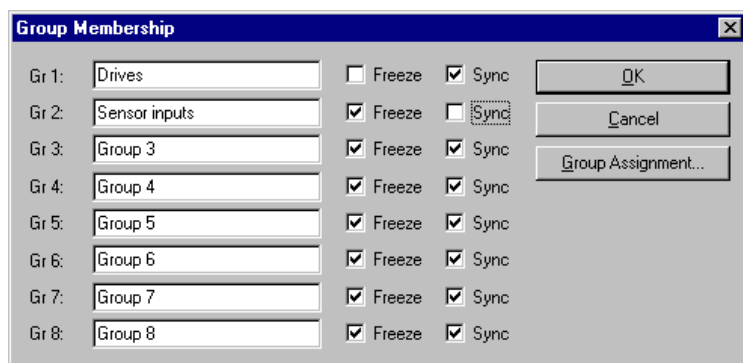

#### Group Assignment

The 'Group Assignment' button provides access to the 'Group Assignment' dialog box, in which slaves can be assigned to the groups. Each slave may be assigned to any number of groups. If a slave does not support SYNC and/or FREEZE functions, assignment to a group with this function is not possible.

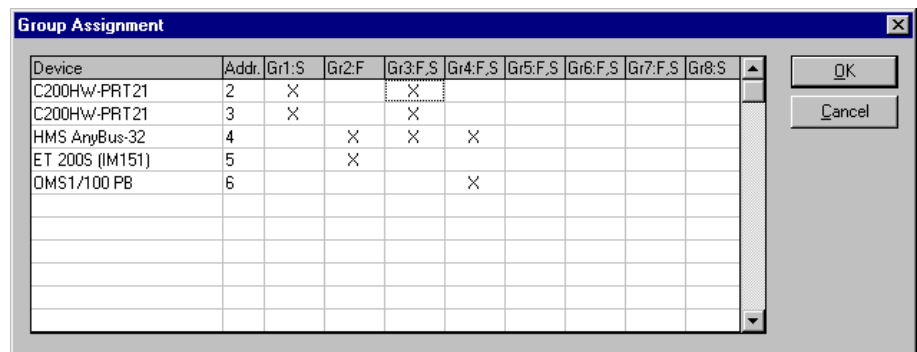

### 4-3-6 Check I/O assignments

After the slaves have been configured, it is possible to obtain an overview of all configured devices and their data allocation in the I/O buffers, by the menu items 'View – Device table' and 'View – Address table'.

#### Device table

The Device table shows all configured slaves, in the order in which they were defined. This order is particularly important for the auto-addressing function: offsets in the I/O buffer will be assigned to slaves in the order in which they are presented in this device list. Slave addresses can be assigned and redefined in any sequence, and do not influence the automatic addressing function.

Addr.	Device	Ident number	Type	Description
1	C200HW-PRM21	0x1656	DP Master	Master1
5	PRT1-COM	0x047D	DP Slave	Slave5
2	C200HW-PRT21	0x04AC	DP Slave	Slave2
7	PRT1-COM	0x047D	DP Slave	Slave3

#### Address table

The address table shows the start address and data length of each slave or slave module in the Master's input and output buffers.

The data location ('I Addr.', 'O Addr.') is always given as an offset in Words, relative to the start of the buffer.

The 'Type' indication of each slave (module) shows if it concerns input (I) or output (Q) data, and if the data is byte (B) or word (W) oriented. This type determines also if the shown length ('I Len', 'O Len') is in Bytes or in Words.

If auto-addressing is enabled, the address list is recalculated each time it is accessed.

The address table has two sorting methods:

1. Sort according to station address. This sorting method is most convenient to find the location of a particular slave (module) in the I/O buffers.

Addr.	Slot	Idx	Device	Module	Symbol name	I Type	I Addr.	I Len.	Q Type	O Addr.	O Len.
2	1	1	C200HW-PRT21	DEFAULT MODE	Module1	Iw	3	2	Qw	3	2
5	1	1	PRT1-COM	System status	Module1	IB	0	4			
5	2	1		GT1-ID16: 16 Digital	Module2	IB	2	2			
5	3	1		GT1-OD32: 32 Digital	Module3				QB	0	4
5	4	1		GT1-OD16: 16 Digital	Module4				QB	2	2
7	1	1	PRT1-COM	System status	Module1	IB	5	4			
7	2	1		GT1-DA04: 4 Analog	Module2				QB	5	8
7	3	1		GT1-DA04: 4 Analog	Module3				QB	9	8

Sorted by station address.



- Sort according to data address. This sorting method is most convenient to find which slave's data is available at a given buffer location.

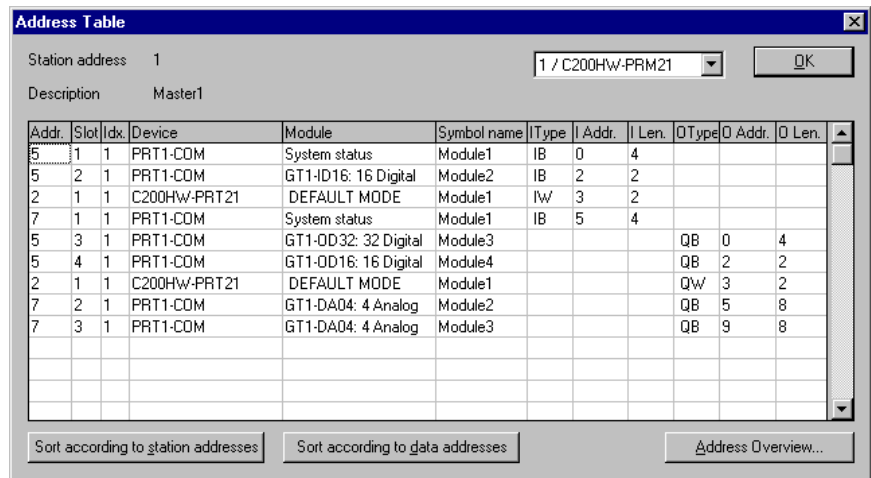

Sorted by data address.

The allocation of each Byte of each module can be checked by clicking the button 'Address Overview...'.

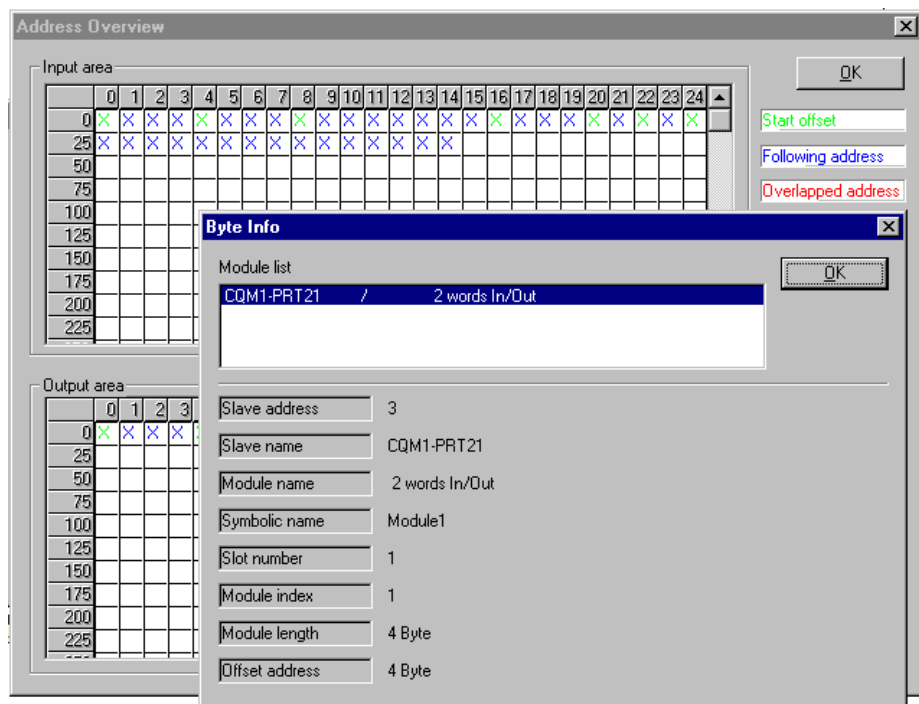

By double-clicking an individual byte, it is possible to check from which module in which slave unit the data originates.

### 4-3-7 Bus parameters

The menu item 'Settings – Bus parameters' leads to a dialog box where the overall PROFIBUS-DP communication parameters can be set. In most cases, only the baud rate will need to be set to the required value. This can be done in the following panel:

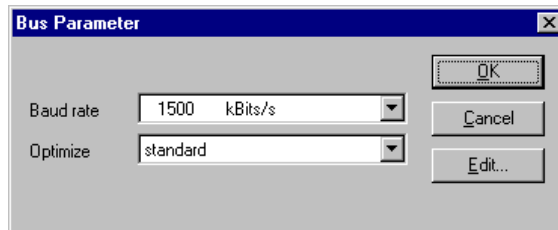

The configurator will verify that the selected baud rate is supported by all devices connected to the master, and issue a warning if this is not the case.

'Optimize = standard' will automatically adjust all bus parameter settings to a value derived from the data found in the slaves' GSD files, and the selected baud rate. These values can be viewed by clicking the 'Edit...' button.

Only in extreme cases it may be required to adjust these settings, i.e. with exceptionally large configurations (>80 slaves), or when using a large number of repeaters or signal converters.

For manual adjustment of bus parameters, select 'Optimize = by user' and click 'Edit...'.

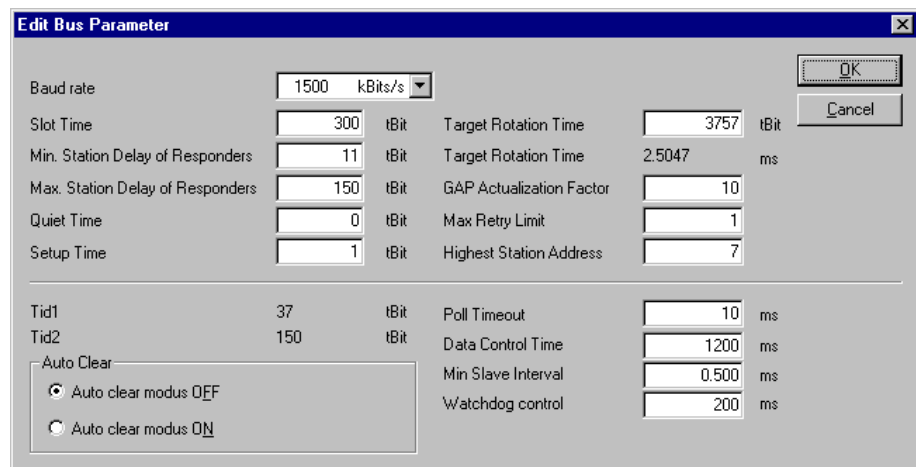

**⚠ Caution**

It is highly recommended to access the bus parameter panel *after* all slaves have been configured. By *changing* the baud rate, all timing parameters will be optimised for the number and types of defined slaves. If the configuration is subsequently modified, select the chosen baud rate *again* to re-activate the parameter optimisation. If any bus parameter is modified manually, no automatic recalculation will take place until the baud rate is changed.

**Baud rate** Sets the communication speed for the master and all slaves which support auto baud rate detection. All standardised PROFIBUS-DP values from 9.6 kbit/s to 12 Mbit/s are supported by the C200HW-PRM21. A change of baud rate will recalculate all parameters to a value optimised for the actual configuration at the new baud rate.

Slot Time ( $T_{SL}$ )	The maximum time the Master must wait for a transaction response.
Station Delay of Responders ( $T_{SDR}$ )	The minimum and maximum allowed times for a slave to generate a reply frame.
Quiet Time ( $T_{QUI}$ )	The time a transmitting station must wait after the end of a frame before enabling its receiver.
Setup Time ( $T_{SET}$ )	The time between an event and the necessary reaction.
Target Rotation Time ( $T_{TR}$ )	The anticipated time for one token cycle, including allowances for high and low priority transactions, errors and GAP maintenance (set in bit times, value in ms is calculated). Do not decrease $T_{TR}$ below the suggested value, otherwise bus communication may get interrupted.
GAP Actualisation Factor	<p>GAP is defined as the range between this master and its successor in the logical token ring (i.e. in case more than one active station operates on the same bus).</p> <p>The master will periodically check if new active stations have been added between address 0 and the Highest Station Address (see below). If stations are detected, GAP is updated.</p> <p>The factor defines the checking period in multiples of the Target Rotation Time (<math>T_{TR}</math>). Allowed values are 1 to 255.</p>
Max. Retry Limit	Maximum number of retries by this master, if a station does not properly respond to a request.
Highest Station Address (HSA)	Defines the maximum range of addresses in which this master periodically searches for newly added active stations. If multiple masters are to operate on the same bus, set HSA at least equal to the highest master address.
Poll Timeout	The maximum time interval that this master station may need for the execution of a master-master function (respond to a DPM2 request).
Data Control Time	<p>The cycle time in which this master updates its Data Transfer List in which it keeps an overview of all slave states, and indicates its operation mode to the associated DP slaves.</p> <p>Data Control Time is automatically set to the recommended value of <math>6 \cdot T_{WD}</math>.</p>

Min. Slave Interval	The smallest allowed period of time between two slave poll cycles. This value is determined by the largest value of all Minimum Slave Interval values as read from the GSD files of the configured slaves. This ensures that all slaves can handle the sequences of requests they receive from this master.
Watchdog Control Time ( $T_{WD}$ )	If a slave's watchdog is enabled, and it does not detect master activity for a period $T_{WD}$ , it will set its outputs to a fail-safe state. $T_{WD}$ is automatically set for all configured slaves, based on the value of $T_{TR}$ .
Auto_clear Mode OFF/ON	Determines if the master will change from Operate to Clear mode if it detects that one or more configured slaves are not in data exchange mode.  If Auto_clear mode is ON, a single slave failure will thus reset the outputs of all active slaves.



**Caution**

### 4-3-8 Download

#### No Upload

The PROFIBUS-DP configuration, defined offline, needs to be downloaded into the C200HW-PRM21. Please note that uploading the configuration data from the unit is not possible, since detailed information concerning slaves and modules will not be saved in the Unit. Therefore it is advised to save your configuration on disk before starting a download.

#### When to download

There are two situations in which a configuration download is allowed.

The first situation is when on startup, the Unit has detected that a corrupted database is present in its non-volatile memory. In this case the RUN LED is flashing and the DP-ERR LED is ON. As soon as the download is started, the DP-ERR LED goes OFF and the READY LED will flash. When the download is successful and a valid database is detected, the initialisation of the unit will continue.

The second situation is after initialisation is completed. This is when the RUN LED is ON. During the download, the READY LED will flash and the other PROFIBUS-related LEDs will be OFF. After completion of the download, the received database is checked. If the database is valid, the Unit is re-initialised; and the READY LED is turned ON. If the database is invalid, the DP-ERR LED will be ON and the user needs to re-execute the download.

**Note** Do not start a download in another situation than described above. The download will most likely fail, requiring a restart of the Unit.

#### Device Assignment

Before a download, make sure a serial port of the PC is connected to the CONF port of the Unit using a cable as specified in 2-1-4, '*Configurator Connector*'.

Make sure the cursor is on the targeted Master station, then select the menu item 'Settings – Device Assignment'. Click the 'Connect COMx' buttons to test the connection to the Master unit. If the test succeeds, version information will be displayed as shown.

If multiple masters are connected to various COM ports, make sure the correct check box is selected.

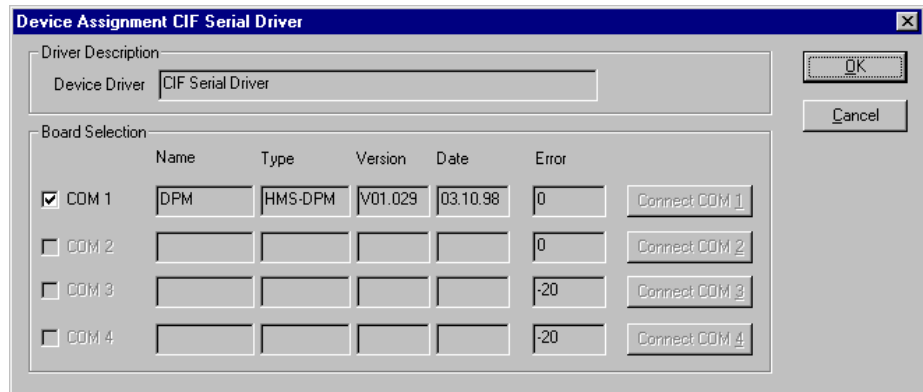

**Download**

Upon selecting 'Online – Download', the software will verify if the device assignment has been made. If necessary, the user will be prompted to select a serial port.

If the download is started, the C200HW-PRM21 will stop all communication on PROFIBUS-DP until the download is completed.

**Slave overlap**

Before actually starting the download, the configurator will first perform a number of checks on the entered configuration data.

If any slave data is found to overlap with another slave or module, the download is aborted. An error message is displayed to indicate the first allocation problem that was encountered, e.g.:

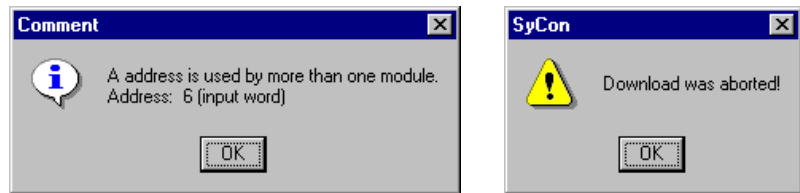

Use the address table viewer to locate the problem, and resolve the conflict by modifying the offset of one or more slaves.

When auto-addressing mode is selected, all slave offsets are recalculated before a download, and no allocation conflicts should occur. The calculated offsets can be verified in the address list.

If all checks have passed successfully, a progress indicator is displayed:

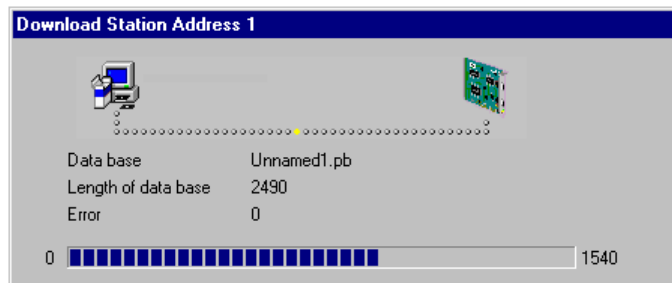

Downloading the configuration data will take several seconds, depending on the size of the configuration. After the download, the C200HW-PRM21 will restart. If the unit does not respond correctly, the download will be aborted.

## 4-4 Debug mode

The C200HW-PRM21 configurator software SyCon allows the user to inspect the status of the unit and the assigned slaves online via the CONF port of the Master Unit.

### Configuration file

In order to reliably display the status of the PROFIBUS-DP network, the correct configuration file must be open in the configurator. Immediately after a download this is automatically the case; if the unit has to be accessed for debugging in a later stage, the user must make sure that the correct file is opened before activating the debug function. The configuration file cannot be uploaded from the unit.

The debug function can be started via the menu command 'Online – Start Debug Mode'.

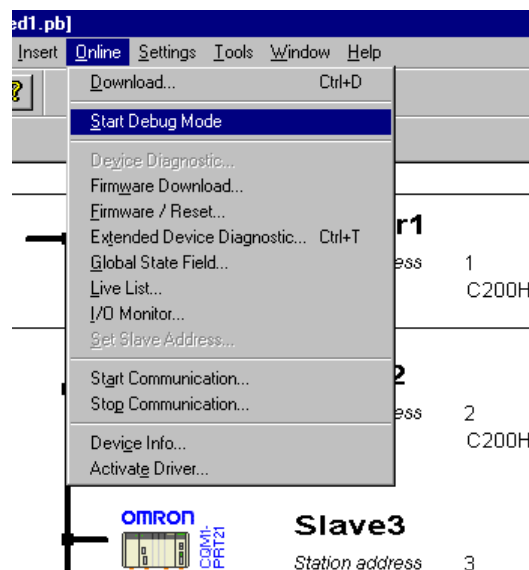

### Functions

The Debugger provides the following functions:

- Display of master unit status.
- Display of PROFIBUS-DP network state.
- Display of each slave's state, including slave diagnostics (standard + extended).

The following Online functions are not supported by the C200HW-PRM21:

- Firmware download
- Firmware / Reset
- I/O Monitor
- Start Communication
- Stop Communication
- Device Info
- Activate Driver

**⚠ WARNING** Execution of the 'Firmware download' and 'Firmware/Reset' functions may lead to permanent corruption of the firmware of the C200HW-PRM21.

'Start/Stop Communication' should be performed using the 'I/O Communication Inhibit' bit in the PLC (see 5-3-1 *Control words*).

'I/O Monitor', 'Device Info' and 'Activate Driver' will cause no damage or corruption of data, but will display incorrect information.

### 4-4-1 Master Diagnostics

#### Master Status

The state of the PROFIBUS-DP Master can be monitored through the menu item 'Online – Global State Field', or while in debug mode, by double-clicking on the Master unit's icon, and selecting 'Global State Field' from the list shown below, and clicking 'Display':

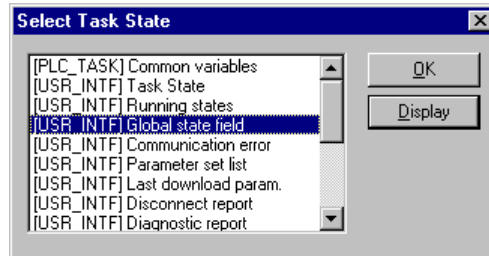

Please note that not all items from the Task State list are supported by the C200HW-PRM21. Invalid data may be displayed in some of the views.

The 'Global Task State' window shows the status of the Master Unit and its slaves. For a detailed explanation of the data shown, please refer to the Help files of SyCon (Press F1).

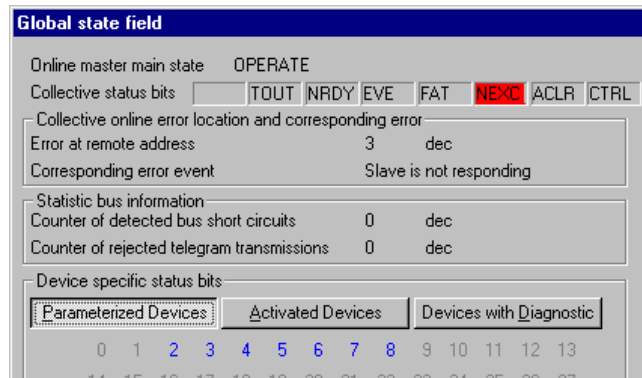

'Online master main state' indicates the same as the upper 2 bits of status word IR n+2, i.e.:

- C0 = OPERATE
- 80 = CLEAR
- 40 = STOP
- 00 = OFFLINE

### 4-4-2 Slave Diagnostics

#### Slave Status

In debug mode, the bus configuration display shows a status overview of all configured devices:

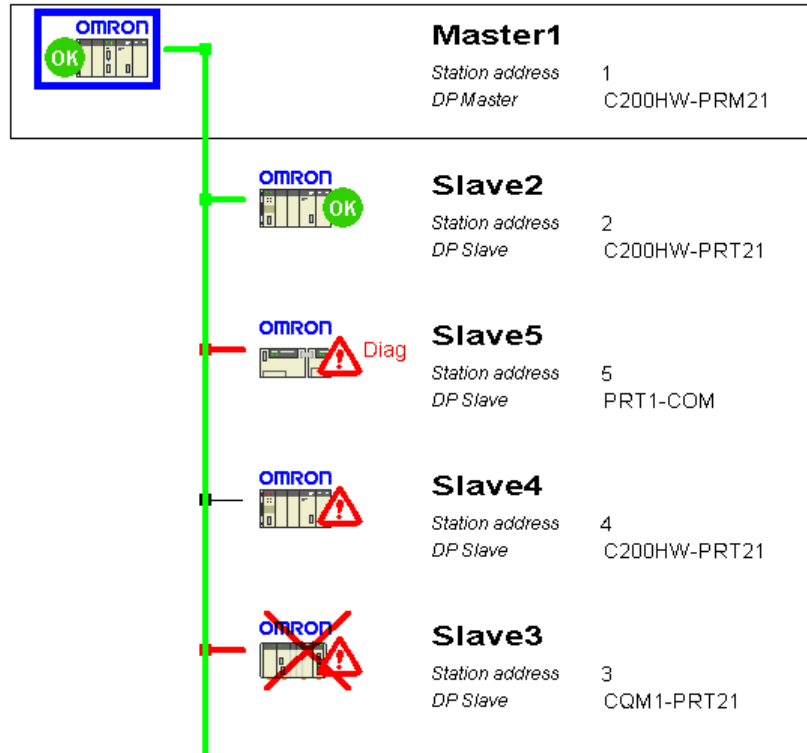

The station's status is indicated by the colour of connection to the main bus line, and by the displayed image of the device.

- Green** Normal data exchange with this slave.
- Red** Slave has diagnostic information or the master couldn't find this slave on the bus, i.e. there is no data exchange with this slave.

- A thin, black connecting line (e.g. Slave 4) indicates that the slave is not assigned to the selected master unit. The status of this slave cannot be monitored.
- A cross through the slave icon (e.g. Slave 3) indicates that the slave was defined to be not active in the current configuration (See 4-3-4 *Device configuration*).

#### Slave Diagnostic

A double click with the mouse on a slave device calls up more detailed diagnostic information. Slave diagnostics are displayed as defined in the PROFIBUS-DP standard EN 50170.

Diagnostic information in this window is not updated online. Close and reopen the window to refresh the information.

For a detailed explanation of the displayed information, consult the online Help system (press F1).



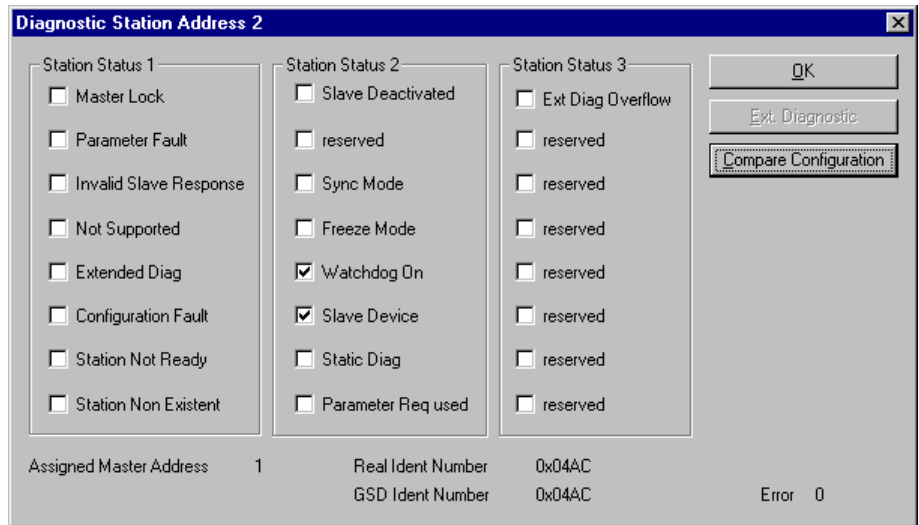

If the flag 'Extended Diag' is set, the slave has additional diagnostic information, and the button 'Ext Diagnostic' will be available. Extended diagnostics will be displayed in a separate window.

### 4-4-3 Extended diagnostics

The displayed extended diagnostic texts are dependent on the information provided in the device's GSD file. SyCon translates the diagnostic message as received from the slave in hexadecimal format (bottom window) into the texts as specified in the GSD file. Different language versions of the GSD file may be available from the manufacturer.

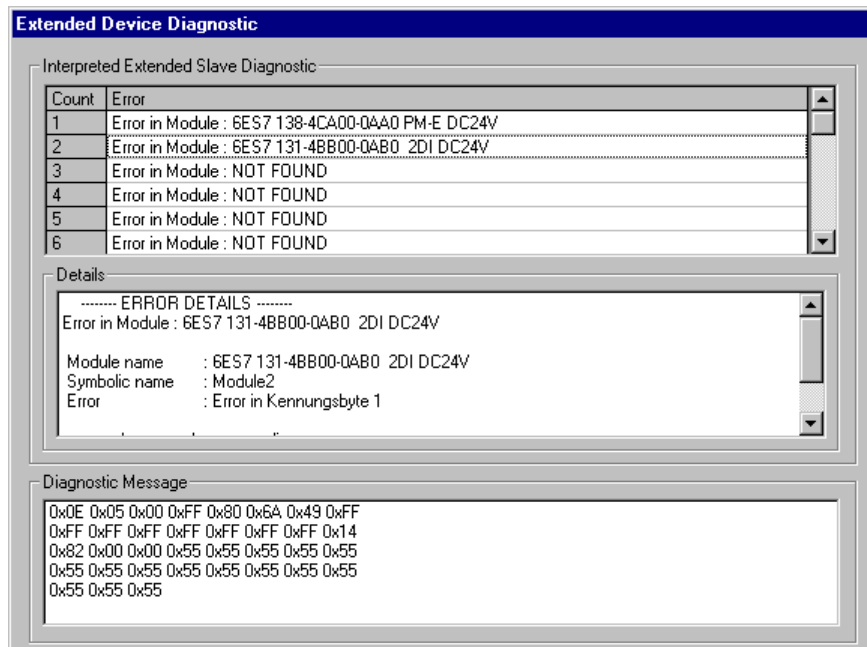

If multiple messages are available, they can be selected for display using the scroll bar on the right.

The meaning of the displayed messages is slave dependent, and should be described in the slave's documentation.



# 5 PLC Interface

This section describes the interface with the user via the PLC system. This includes Unit settings to configure the Unit and the control / status area.

5-1 Unit Settings.....	52
5-1-1 I/O Data Mapping .....	52
5-1-2 Slave Status Area Mapping .....	57
5-1-3 Data Exchange Method.....	57
5-1-4 Fatal PLC error handling .....	58
5-2 Input / Output Mailbox.....	59
5-3 Control and status area .....	60
5-3-1 Control words.....	61
5-3-2 Status words .....	64
5-4 LEDs .....	70

## 5-1 Unit Settings

This Special I/O Unit is configurable with settings made in a dedicated DM area. The assigned DM area depends on the Unit number setting.

Unit number	DM area*	
0	DM1000 ~ DM1017	All PLC models
1	DM1100 ~ DM1117	
2	DM1200 ~ DM1217	
3	DM1300 ~ DM1317	
4	DM1400 ~ DM1417	
5	DM1500 ~ DM1517	
6	DM1600 ~ DM1617	
7	DM1700 ~ DM1717	
8	DM1800 ~ DM1817	
9	DM1900 ~ DM1179	
A	DM2000 ~ DM2017	All PLC models except: C200HS, C200HE, C200HG-CPU3[ ]-E/CPU4[ ]-E, C200HX-CPU3[ ]-E/CPU4[ ]-E
B	DM2100 ~ DM2117	
C	DM2200 ~ DM2217	
D	DM2300 ~ DM2317	
E	DM2400 ~ DM2417	
F	DM2500 ~ DM2517	

\* Alternatively starting at DM7000 ~ DM8500, selected by PLC setup of C200H...: DM6602 ≠ 0000 (see Operation Manual of CPU unit)

The first word in the DM area allocated to the unit will be indicated by **DM m**, the last word by **DM m+17**.

The Unit settings determine the areas and methods for data exchange between the PLC CPU and the C200HW-PRM21.

Data entered in the Unit settings area is only transferred to the unit during initialisation, i.e. at power ON and at Special I/O Unit restart.

**Note** The Unit operates in default mode when all Unit settings are set to zero.

### 5-1-1 I/O Data Mapping

#### Data flow

The figure below shows the flow of remote I/O data in the PLC system. It is possible to map the I/O data to the DM, LR, IR and HR areas of the PLC memory. Up to two input areas and two output areas may be assigned.

Output data is transferred via the bus on the Backplane (I/O Bus) to the output buffer of the Unit. At certain time intervals this data is transmitted to the slaves over PROFIBUS. Slave input data coming from PROFIBUS is first stored in the input buffer of the Unit. At certain times, this data is transferred to the memory of the PLC. The exchange of data via the I/O Bus occurs during an I/O refresh.

#### I/O refresh

By default, I/O refreshes are executed at the end of each PLC program cycle, but can also be triggered by the IORF instruction.

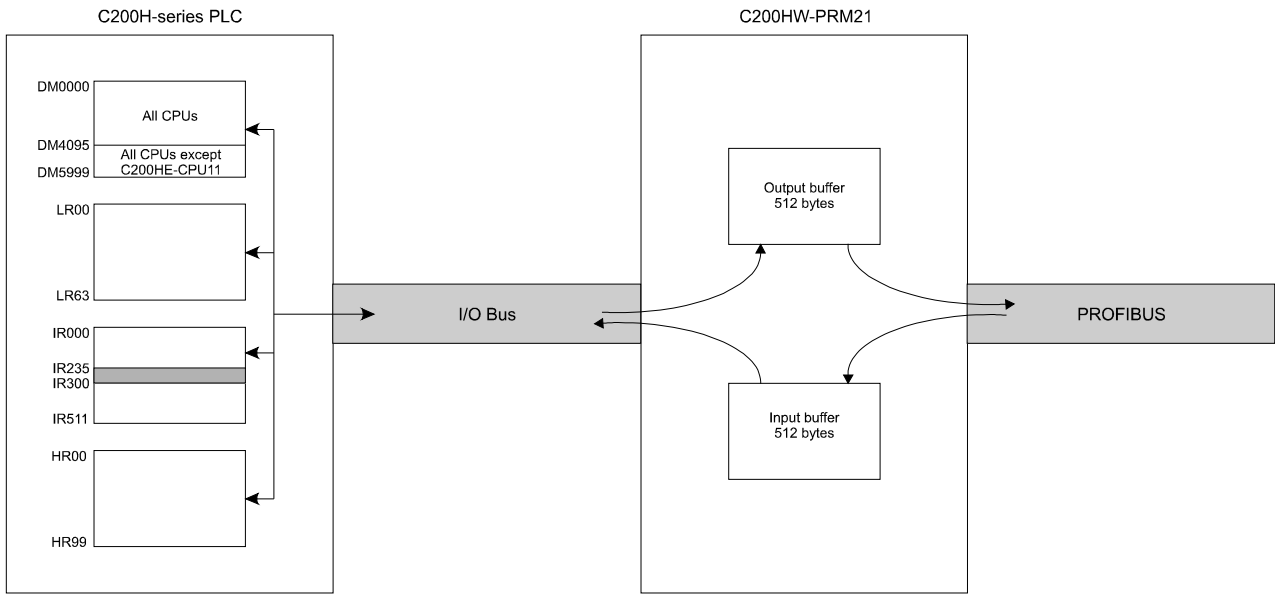

**User configurable**

The mapping of the PROFIBUS-DP slaves onto the buffers of the Unit is defined with the configurator described in section 4. The mapping between the I/O data buffers of the Unit and the PLC memory is user configurable via the settings in data memory.

**Maximum I/O data**

For C200HS, the maximum number of mapped I/O data is 80 words and for C200HE, C200HG, C200HX and CS1-series, the maximum is set to 300 words. If the user-defined mapping exceeds these values, the mapping is ignored (no data will be exchanged) and a fatal error is indicated in IR n+2 (see section 5-3) and the ERR LED is turned ON.

The maximum amount of data mapped per single transfer block is 100 words.

**Data representation**

In the I/O data buffers, the high bytes of PLC data always occupy even addresses, the low bytes occupy odd addresses (Motorola format).

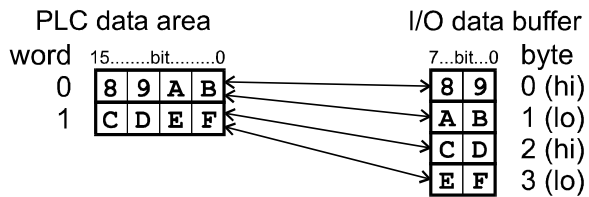

The representation of PROFIBUS-DP slave data in the I/O data buffer depends on the specifications of the slave. Please consult the slave manufacturers' documentation. In rare cases it may be necessary to modify the data representation either at the slave side, or in the PLC program.

The table below lists the DM words for configuring the I/O data mapping, with the possible values and their meaning.

### Setting values in BCD

Except for the definition of the start address in the PLC CPU, all values are in BCD. To be able to distinguish between start addresses in different PLC memory areas, the first digit of the 'start address' indicates the PLC memory area, the following three digits indicate the address in the PLC memory area in BCD format.

### Words vs. Bytes

Note that data allocation in the PLC memory is in WORD units, whereas the allocation in the Unit's buffers is in BYTE units (1 word = 2 bytes). The start address in an I/O data buffer area must always be even. Odd-valued entries will generate a setting error.

### CS1-series

For details on I/O data mapping on CS1-series PLC's, see Appendix C.

DM word	Value	Meaning
m	<b>Number of output data areas</b>	
	0000	Default mapping C200HS: PLC addresses IR050 ~ IR081 are mapped to Unit output buffer bytes 000 ~ 063 C200HE,C200HG,C200HX: PLC addresses IR050 ~ IR099 are mapped to Unit output buffer bytes 000 ~ 099
	0001	One user-defined data output area
	0002	Two user-defined data output areas
	other	Default mapping (see value 0000)
m+1	<b>Output area 1 : start address in the output buffer</b>	
	0000 ~ 0510	Byte 000 ~ 510 (even) in output buffer of the Unit
	other	Setting error <sup>*1</sup> , output area is ignored
m+2	<b>Output area 1 : start address in the CPU</b>	
	0000 ~ 4095	DM0000 ~ DM4095 (C200HE-CPU11)
	0000 ~ 5999	DM0000 ~ DM5999 (all other CPUs)
	A000 ~ A235	IR000 ~ IR235
	A300 ~ A511	IR300 ~ IR511
	B000 ~ B099	HR00 ~ HR99
	C000 ~ C063	LR00 ~ LR63
	other	Setting error <sup>*1</sup> , output area is ignored
m+3	<b>Output area 1 : size</b>	
	0000 ~ 0100	0000 ~ 0100 words to be transferred from PLC to Unit output buffer <sup>*2</sup>
	other	Setting error <sup>*1</sup> , output area is ignored
m+4	see m+1	<b>Output area 2 : start address in the output buffer</b>
m+5	see m+2	<b>Output area 2 : start address in the CPU</b>
m+6	see m+3	<b>Output area 2 : size</b>

continued →

DM word	Value	Meaning
m+7	<b>Number of input data areas</b>	
	0000	Default mapping C200HS: Unit input buffer bytes 000 ~ 063 are mapped to PLC addresses IR350 ~ IR381 C200HE,C200HG,C200HX: Unit input buffer bytes 000 ~ 099 are mapped to PLC addresses IR350 ~ IR399
	0001	One user-defined data input area
	0002	Two user-defined data input areas
	other	Default mapping (see value 0000)
m+8	<b>Input area 1 : start address in the input buffer</b>	
	0000 ~ 0510	Byte 000 ~ 510 (even) in input buffer of the Unit
	other	Setting error <sup>*1</sup> , input area is ignored
m+9	<b>Input area 1 : start address in the CPU</b>	
	0000 ~ 4095	DM0000 ~ DM4095 (C200HE-CPU11)
	0000 ~ 5999	DM0000 ~ DM5999 (all other CPUs)
	A000 ~ A235	IR000 ~ IR235
	A300 ~ A511	IR300 ~ IR511
	B000 ~ B099	HR00 ~ HR99
	C000 ~ C063	LR00 ~ LR63
	other	Setting error <sup>*1</sup> , input area is ignored
m+10	<b>Input area 1 : size</b>	
	0000 ~ 0100	000 ~ 100 words to be transferred from Unit input buffer to PLC <sup>*2</sup>
	other	Setting error <sup>*1</sup> , input area is ignored
m+11	see m+8	<b>Input area 2 : start address in the input buffer</b>
m+12	see m+9	<b>Input area 2 : start address in the CPU</b>
m+13	see m+10	<b>Input area 2 : size</b>

<sup>\*1</sup> Setting errors are indicated in IR n+2 (see section 5-3) and the ERR LED will be flashing to indicate a non-fatal error.

<sup>\*2</sup> If the specified number of words would make the area exceed the boundaries of the available buffer, DM, LR, IR or HR areas, the actual number of transferred words will be limited as to remain within all of these boundaries. This setting error is indicated in IR n+2 (see section 5-3) and the ERR LED will be flashing to indicate a non-fatal error.

- Notes**
- The Unit does not check the validity of the contents of any PLC data area, from which output data is to be transferred. Any data present in the area will be transferred to the output buffer of the Unit.
  - If multiple fieldbus masters (e.g. PROFIBUS-DP, CompoBus/D, SYSMAC BUS) are mounted on the same PLC system, only one of them can be used in default mapping mode. The Unit does not check if the mapped PLC input area is in use by other Units. If so, this Unit's data may overwrite another Unit's data, or vice versa.
  - If the settings cause two destination areas to overlap, the data of the higher number area will overwrite the lower. This practice is to be avoided by the user.

**Example I/O data mapping**

Below is an example of user-defined I/O data mapping. The unit number is set to 0, so the settings start at DM word 1000. The example defines two output areas and one input area.

DM word	Value	Meaning
1000	0002	Two output areas
1001	0000	Write to output buffer of Unit starting at address 000
1002	B050	Read data from PLC starting at HR50
1003	0020	Transfer 20 words of output data
1004	0520	Write to output buffer of Unit starting at address 520
1005	C000	Read data from PLC starting at LR00
1006	0050	Transfer 50 words of output data
1007	0001	One input area
1008	0400	Read data from input buffer of Unit starting at address 400
1009	A500	Write data to PLC starting at address IR500
1010	0100	Transfer 100 words of input data
1011	any	No 2 <sup>nd</sup> input area
1012	any	No 2 <sup>nd</sup> input area
1013	any	No 2 <sup>nd</sup> input area

The first output area is correctly defined, all values are in range.

The second output area has an incorrect value for the start address in the output buffer of the Unit (520 > 510). This output area will not be mapped; the output data will not be transferred to the buffer. This setting error is indicated in IR n+2 (see section 5-3) and the ERR LED will be flashing.

Also the input area definition causes a setting error. The specified number of words to be transferred crosses the boundaries of both the available IR area and the input buffer area. The available input buffer area is 112 bytes (400 ~ 511) and the available IR area is 12 words (IR500~IR511). The number of input words that will be transferred is therefore limited to 12 words = 24 bytes (the lesser of the two values). This is also a setting error which will be indicated in IR n+2.



### 5-1-2 Slave Status Area Mapping

DM m+14 and DM m+15 define the PLC data area where the 16 words of slave status information are to be mapped. By default (i.e. both settings are 0) the Unit uses IR200 ~ IR215, an IR area originally reserved for SYSMAC BUS slaves. Therefore, if the Unit is used in combination with a SYSMAC BUS remote master unit, the default mode should not be used.

DM word	Value	Meaning
m+14	<b>Slave status data mapping mode</b>	
	0001	User defined mapping defined by DM m+15
	other	Default mapping to IR200 ~ IR215
m+15	<b>Start address in user-defined mapping mode (Area size = 16 words)</b>	
	0000 ~ 4080	DM0000 ~ DM4080 (C200HE-CPU11)
	0000 ~ 5984	DM0000 ~ DM5984 (all other CPUs)
	A000 ~ A220	IR000 ~ IR220
	A300 ~ A496	IR300 ~ IR496
	B000 ~ B084	HR00 ~ HR84
	C000 ~ C048	LR00 ~ LR48
	other	Default mapping to IR200 ~ IR215

The user is to verify that the assigned area is not yet allocated to other Units.

### 5-1-3 Data Exchange Method

DM m+16 defines the data exchange procedure between the Unit and the PLC. The two possible exchange methods are:

1. Asynchronous: the fieldbus cycles are triggered independently of the PLC cycle and therefore the fieldbus cycles run asynchronous with the PLC cycle. This method provides optimal I/O response time when the PLC cycle time is at least twice the fieldbus cycle time.
2. Synchronous: The fieldbus cycles are triggered at the end of an I/O refresh and therefore the fieldbus cycle is synchronised with the PLC cycle. If the fieldbus cycle time is greater than the PLC program execution time, the next fieldbus cycle will not be triggered until the completion of the next I/O refresh. This method ensures synchronisation between PLC cycle and fieldbus cycle.

These exchange methods are described in more detail in section 3-2.

DM word	Value	Meaning
m+16	<b>Data exchange procedure</b>	
	0000	Default, fieldbus cycle asynchronous with PLC cycle
	other	Fieldbus cycle synchronous with PLC cycle

**Note** In synchronous mode, with the slave watchdog enabled (configurable), the PLC cycle time should be less than the set watchdog time (configurable) otherwise the watchdog of the slave will expire. If the PLC cycle time can not be reduced, the watchdog time of the slave must be set to a larger value, or the asynchronous mode must be used.

### 5-1-4 Fatal PLC error handling

DM m+17 defines the handling of fatal PLC errors. The Unit will react on a falling edge of Run bit IR n.00. The Run bit will turn OFF in case of:

- a fatal error in the PLC system, e.g. Memory error, I/O bus errors.
- a system FALS error.
- a user-generated FALS error.
- a PLC CPU mode change to/from Program mode.

If any of these situations occur, the remote outputs will be switched to a user-defined state. If the data exchange mode (selected with DM m+16) is asynchronous, DM m+17 allows the user to choose between:

CLEAR outputs:

The output data in the Output buffer is cleared and transmitted to the slaves (if communication is not inhibited).

HOLD outputs:

The output data in the Output buffer is not transmitted to the slaves anymore; the outputs of the slaves remain the previous state.

DM word	Value	Meaning
m+17	<b>Fatal PLC error handling (asynchronous data exchange mode)</b>	
	0000	CLEAR outputs
	other	HOLD outputs

 **Caution** This selection is ONLY valid when the Unit operates in the asynchronous data exchange mode (i.e. DM m+16 = 0000). Even if program execution stops, fieldbus communication is maintained by the Unit, independent of the PLC cycle.

In synchronous data exchange mode, when program execution stops, no fieldbus cycles are triggered. Therefore the remote output status cannot be maintained. The status of PROFIBUS-DP will automatically change to CLEAR, followed by STOP. All outputs will be cleared automatically, even if DM m+17 specifies to hold the outputs!

**Note** The Unit is not able to distinguish between a user-controlled reset of the IR n.00 bit and a reset due to a fatal PLC error. Both are handled in the same way. Be aware that changing the to/from Program mode will also reset IR n.00. In Program mode, it is possible to force IR n.00 to the ON state, so that remote I/O can be operated for debugging and commissioning.

## 5-2 Input / Output Mailbox

### PROFIBUS-DP specific commands

Beside the input and output buffer, the Unit also contains an input mailbox and an output mailbox. PROFIBUS-DP specific commands can be transferred from the CPU to the output mailbox. The response to the command placed in the output mailbox will be placed in the input mailbox. This response can then be read by the CPU.

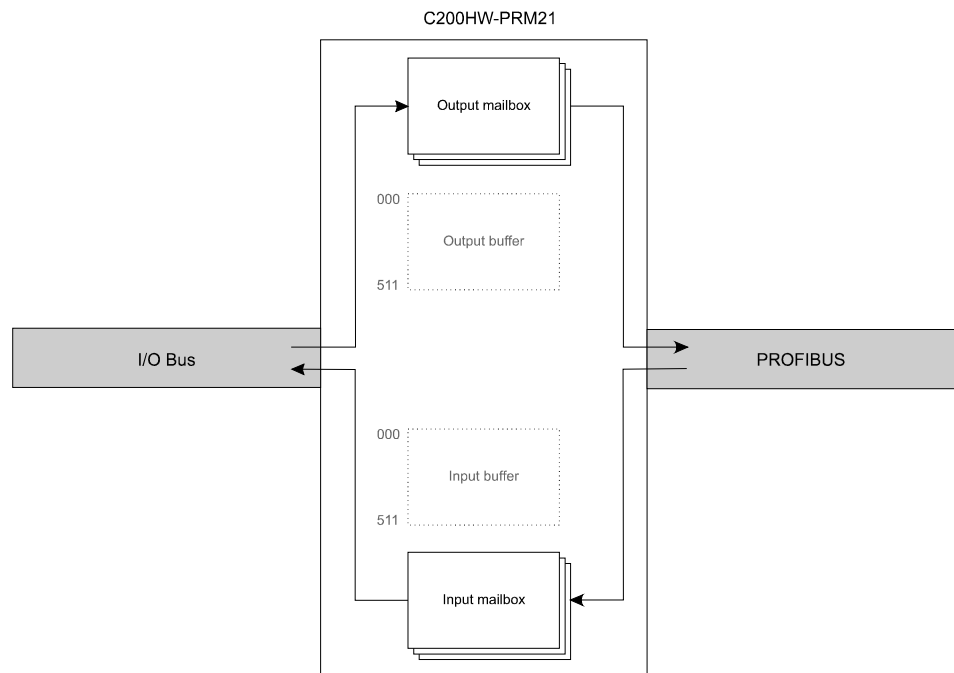

There are two ways to transfer a command to the output mailbox.

1. Issuing a command by IOWR instruction in the PLC program. The contents of the data area specified by the IOWR instruction are transferred to the output mailbox.
2. Via the control words. The most common PROFIBUS-DP control commands can be selected by activating the corresponding bit in the control word IR n. The Unit will interpret this control word and place the corresponding command in the output mailbox.

Responses to these common control commands are automatically removed from the input mailbox. These responses contain no valuable information for the user.

Responses to other commands - issued via IOWR instructions - should be read from the input mailbox with the IORD instruction. If this is omitted, the input mailbox buffer will fill up. When this is the case, the output mailbox will be disabled; it will not be possible to transfer commands to the output mailbox anymore. Once the input mailbox is emptied again, the outstanding commands in the output mailbox will be processed by the unit.

Details about the IOWR and IORD instructions are given in section 6.

**Note** The input mailbox can also be cleared using control word IR n. The status of the mailboxes is indicated in the status word IR n+2.

## 5-3 Control and status area

After initialisation of the unit (RUN LED is ON), the control and status words are exchanged between the PLC and the Unit during each I/O refresh. The mapping of the control words and unit status words depends on the Machine number set by the rotary switch at the front of the Unit.

Unit number	IR area	
0	IR100 ~ IR104	All PLC models
1	IR110 ~ IR114	
2	IR120 ~ IR124	
3	IR130 ~ IR134	
4	IR140 ~ IR144	
5	IR150 ~ IR154	
6	IR160 ~ IR164	
7	IR170 ~ IR174	
8	IR180 ~ IR184	
9	IR190 ~ IR194	
A	IR400 ~ IR404	All PLC models except: C200HS, C200HE, C200HG-CPU3[ ]-E/CPU4[ ]-E, C200HX-CPU3[ ]-E/CPU4[ ]-E
B	IR410 ~ IR414	
C	IR420 ~ IR424	
D	IR430 ~ IR434	
E	IR440 ~ IR444	
F	IR450 ~ IR454	

The first word in the IR area allocated to the Unit will be indicated by **IR n**, the last word by **IR n+4**.

The first two words are control words and are sent *to* the Unit. The next three words are status words and are read *from* the Unit.

The mapping of the slave status words that are read from the Unit is defined by the Unit settings (see section 5-1-2).

**Note** During a configuration download or when a fatal error occurs in the unit, the control words IR n and IR n+1 will not be processed.

### CS1-series

For details on the area allocation in CS1-series PLC's, see Appendix C.

### 5-3-1 Control words

The two control words, IR n and IR n+1, are shown below.

Any bits of the control words which are not assigned to a specific function, can freely be used as work bits. These bits will be ignored by the C200HW-PRM21.

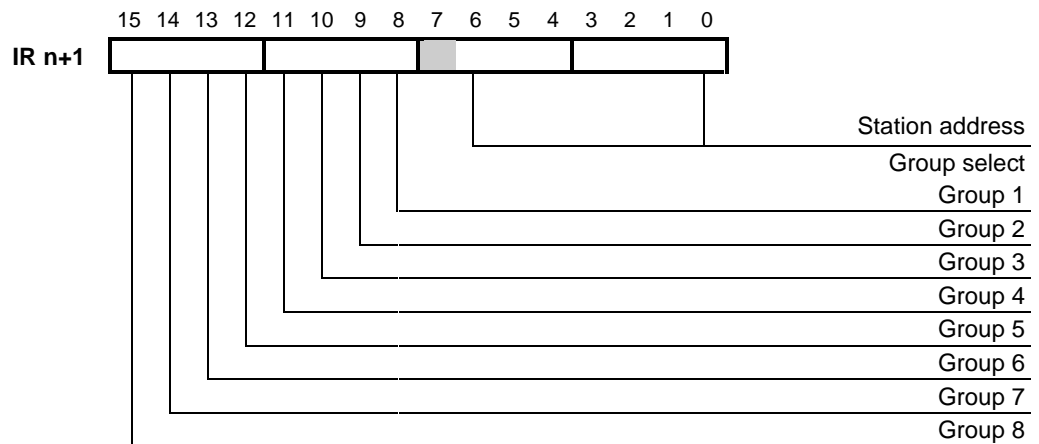
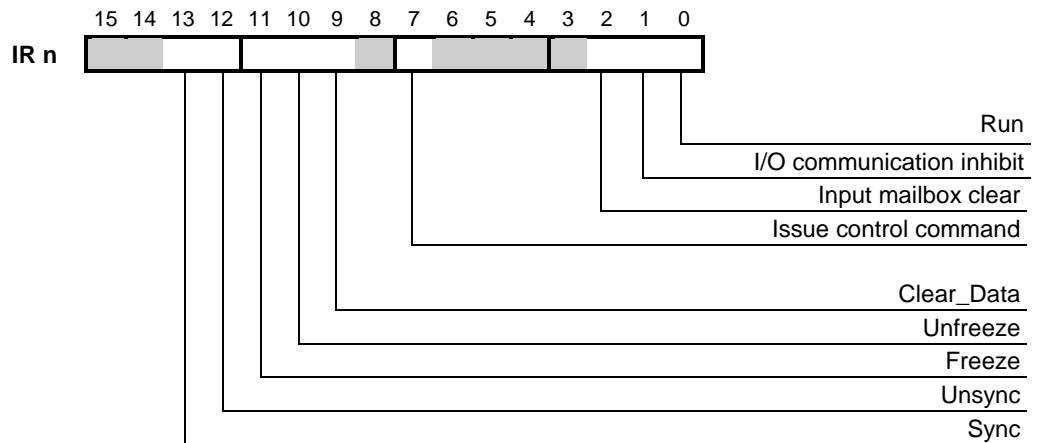

**IR n.00 Run**

0: No exchange of I/O data between PLC and remote I/O, and no processing of mailbox commands will take place. A transition from 1 to 0 will clear or hold the outputs depending on the value set in DM m+17. Holding remote outputs is only available in asynchronous data exchange mode.

1: Unit in normal operation; exchange of I/O data with PLC, and processing of mailbox commands are enabled.

The purpose of this bit is to allow detection of a fatal PLC error. A fatal PLC error will reset the whole IR area; the Unit monitors IR n.00, and on a 1 → 0 transition it performs the action specified in the Unit settings (see section 5-1-4).

Note: It is recommended to always set this bit ON during PLC program execution. See also Appendix Appendix A.

**IR n.01 I/O communication inhibit**

0: I/O communication is enabled.

1: I/O communication is disabled. A transition from 0 to 1 changes the PROFIBUS-DP network state from 'Operate' via 'Clear' to 'Stop'. All remote outputs will therefore be reset.

Data in the input buffer of the Unit will no longer be updated and transferred to the PLC anymore (I/O refresh time will decrease). The PLC's output data however, is still transferred to the output buffer of the Unit. This ensures that the output buffer contains valid output data at the moment the communication is enabled again.

When I/O communication is disabled, the output mailbox is disabled as well. It is possible to send mailbox commands to the Unit, but they are not transferred to the output mailbox. Because no commands are put in the output mailbox, no responses will be received in the input mailbox.

**IR n.02 Input mailbox clear**

0: No specific action.

1: Each I/O refresh, one unprocessed response (if available) is removed from the input mailbox.

**IR n.03~06 Not used** by C200HW-PRM21.

**IR n.07 Issue control command**

0: No control commands are issued.

1: Each I/O refresh, one control command is issued.

The control command is specified by IR n.09~13, and the destination is specified by IR n+1. No control command is transferred to the output mailbox if either the RUN-bit (IR n.00) is not set or if the communication is inhibited (IR n.01) or the output mailbox is not ready to receive a command due to a full input mailbox. In the next PLC cycle, IR n+2.11 will indicate whether the control command was accepted or not. Each fieldbus cycle, only one control command will be transmitted.

**IR n.08 Not used** by C200HW-PRM21.

**IR n.09~13** Specification of the PROFIBUS-DP control command.

Bit	Command	Meaning
09	Clear_Data	Clear output data
10	Unfreeze	Unfreeze input data
11	Freeze	Freeze input data
12	Unsync	Unsynchronise output data
13	Sync	Synchronise output data

When activated simultaneously, Unsync has priority over Sync,

and Unfreeze has priority over Freeze.

The Clear\_Data command will always clear the output data, whether the Freeze command is activated or not.

**Note** The control commands 'Freeze' / 'Sync' are overruled by a reset of the slave. The control command has to be issued again after the reset to have the slave working in the desired mode.

IR n.14~15 Not used by C200HW-PRM21.

#### IR n+1 Group select and Station address

PROFIBUS-DP provides multi-peer communication (broadcast and multicast).

#### Multicast

To enable multicast communication, each slave can be assigned to one or more groups (See 4-3-5, 'Group membership'). Up to eight groups can be defined (1~8). A target group for a multicast command is selected by setting the corresponding bit in IR n+1.

A specific slave within a group is selected by specifying its address in the Station address area (hexadecimal). When the Station address value is set to 7Fh, all slaves assigned to the group(s) are selected.

Entering the value 00h in the Group select area of IR n+1 selects all groups. Therefore any single slave can be addressed by entering 00h for Group select and the station address of the slave for Station address. This also enables to address a slave that has not been assigned to a certain group.

#### Broadcast

A broadcast command to all slaves is generated by entering the values 00h for Group Select and 7Fh for Station Address.

Example: The first table shows an example of the assignment of the slaves to groups as made with the configurator.

Stations	Group assignment
02h ~ 20h	no group
21h ~ 40h	group 1
41h ~ 60h	group 2
61h ~ 80h	group 1 and group 2

The second table shows some examples of settings for Group select and Station address, and the resulting selection of slaves that will be targeted by a control command.

Group select	Station address	Selection
00h	15h	slave 15h
01h	75h	slave 75h
01h	15h	-
03h	7Fh	slave 21h ~ 80h
00h	7Fh	slave 02h ~ 80h

**Sync / Freeze control**

The purpose of the control commands Sync and Freeze is to be able to synchronise the outputs and inputs of the slaves.

The data exchange between the master and slaves is based upon the polling technique. This means that the exchange of data between the slave and the master does not occur at the same time for all slaves.

The outputs of the slaves can be synchronised by issuing Sync commands. This function is activated after the first Sync command is sent to the slaves. After activation of this function, the output data sent by the Master does not get through to the output. It is stored in a buffer. The data in the buffer is not transferred to the output until another Sync command is issued. Multicasting a Sync command results in a update of the outputs of all corresponding slaves at the same time. This function can be disabled again by sending an Unsync command.

The Freeze and Unfreeze command work in a similar way. They are meant for synchronising the input data. After activating the function, by sending a Freeze command, the input data is not updated until another Freeze command is sent.

**5-3-2 Status words**

The Unit provides 19 words of status information.

Three words (IR n+2 ~ IR n+4) show the status of the Unit (system status) and 16 additional words show the status of all slaves. System status information is transferred in each I/O refresh, irrespective of the state of the fieldbus system. The slave status information is also always transferred, but is not valid when the PROFIBUS-DP bus communication does not function properly or during the download of a configuration. In that case the slave status information bits will be reset to 0.

**System status**

The three words that indicate the system status are shown below.

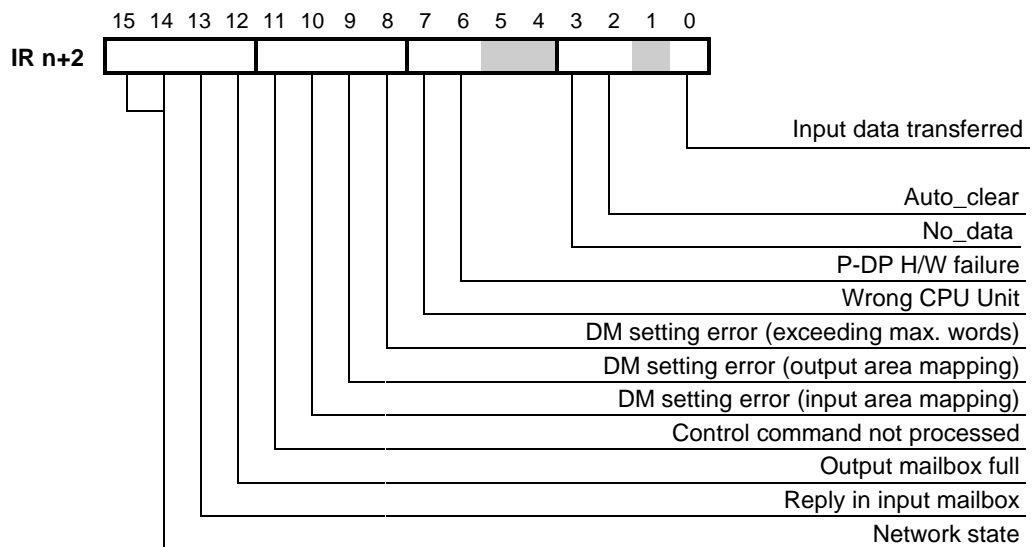

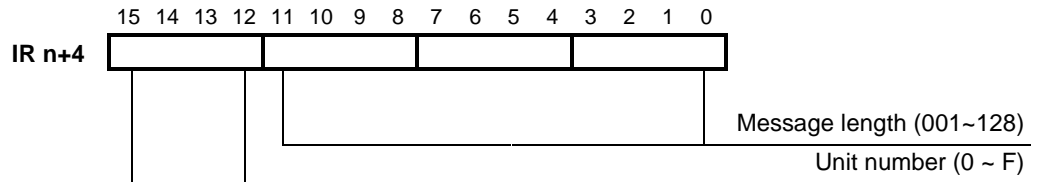
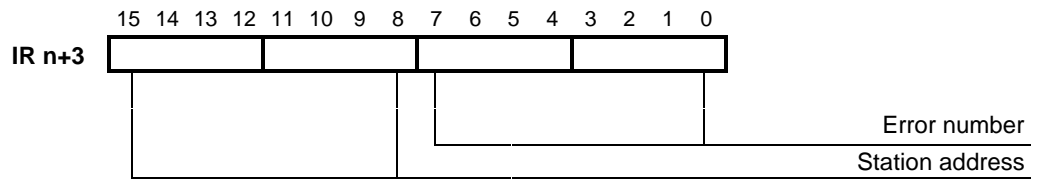

**IR n+2.00 Input data transferred**

- 0: No input data has been transferred to the mapped PLC data area(s) during the last I/O refresh.
- 1: Input data has been transferred to the mapped PLC data area(s) during the last I/O refresh.

The Unit does not always transfer input data to the mapped PLC data area(s). If the Unit cannot provide updated input data during an I/O refresh, no data will be transferred. This will typically occur if the fieldbus cycle time is larger than the PLC cycle time, or if the DP communication has been inhibited.

**IR n+2.01 Not used** by C200HW-PRM21.**IR n+2.02 Auto\_clear** (PROFIBUS-DP status bit).

- 0: Not in Auto\_clear mode. This bit is also cleared during a database download or a P-DP H/W failure is detected (IR n+2.06 is set).
- 1: The master branched into Auto\_clear mode, because of a remote node error.

The master will only branch into Auto\_clear mode when this has been enabled in the configuration (see 4-3-7, Bus parameters). In Auto\_clear mode, the network state bits indicate Stop, and the DP-ERR LED is flashing. IR n+3 will indicate more details about the cause of the error.

To recover from Auto\_clear mode, the C200HW-PRM21 must be restarted (Power OFF / ON or restart bit in AR01 / SR281).

**IR n+2.03 No\_data** (PROFIBUS-DP status bit).

- 0: All remote nodes are in data exchange mode. This bit is also cleared during a database download or when a P-DP H/W failure is detected (IR n+2.06 is set).
- 1: At least one remote node is not in the data exchange mode or reports a fatal error.

The DP-ERR LED is FLASHING to indicate this error. IR n+3 contains more details about the cause.

**IR n+2.04** Not used by C200HW-PRM21.

**IR n+2.05**

**IR n+2.06 P-DP H/W failure**

0: No error

1: Malfunctioning of the PROFIBUS-DP hardware.

The ERR LED is ON to indicate a fatal error, no communication over PROFIBUS.

**IR n+2.07 Wrong CPU Unit.**

0: No error

1: The Unit is mounted to a PLC type which does not support the C200HW-PRM21.

The ERR LED is ON to indicate a fatal error, no communication over PROFIBUS.

**IR n+2.08 DM setting error** (exceeding maximum number of words).

0: No error

1: The input/output area mapping, defined by the Unit's DM settings, exceeds the maximum allowed number of words (300 words for all PLC's, except C200HS: 80 words).

The ERR LED is ON to indicate a fatal error, no communication over PROFIBUS.

**IR n+2.09 DM setting error** (output area mapping)

0: No error

1: There is an error in the output area mapping.

The mapping contains an incorrect value for either:

- the start address in the output buffer in the Master,
- the start address of the output area(s) in the PLC,
- or the size of the output area(s),

or the specified size makes the area(s) exceed the boundaries of available buffer, DM, LR, IR or HR areas.

The ERR LED is FLASHING to indicate a non-fatal error; no data is transferred from the output area(s) afflicted by the setting error(s).

**IR n+2.10 DM setting error** (input area mapping)

0: No error

1: There is an error in the input area mapping.

The DM settings contain an incorrect value for either:

- the start address in the input buffer in the Master,
- the start address of the input area(s) in the PLC,
- or the size of the input area(s),

or the specified size makes the area(s) exceed the boundaries of available buffer, DM, LR, IR or HR areas.

The ERR LED is FLASHING to indicate a non-fatal error; no data is transferred from the output area(s) afflicted by the setting error(s).

**IR n+2.11 Control command not processed.**

This bit is related to control commands sent via the control words IR n and IR n+1, not the one sent via IOWR instruction.

0: The output mailbox was able to receive and process the previously issued control command message.

1: The issued control command could not be processed because the output mailbox was full (see section 5-2) *or* the RUN-bit was not set *or* the bus communication was inhibited.

This bit should be checked in the PLC cycle following the activation of a control command.

**IR n+2.12 Output mailbox full**

0: The output mailbox is able to receive (and process) a message. This message can be a control command issued via IR n or any PROFIBUS command by using the IOWR instruction.

1: The output mailbox is full and cannot receive new messages (see section 5-2).

**IR n+2.13 Reply in input mailbox**

0: The input mailbox does not contain a response message to a command message issued with IOWR.

1: The input mailbox contains a response message to a command message issued with IOWR.

The PLC program should read this message from the input mailbox with IORD, or clear the message by setting IR n.02. If multiple command messages are issued without reading the responses, the input mailbox will fill up, making it impossible to send out further command messages (see section 5-2).

IR n+4 contains the source information for the IORD instruction.

**IR n+2.14 Network state (PROFIBUS-DP status bits).****IR n+2.15**

IR n+2.15	IR n+2.14	Network state
0	0	Offline Communication with all DP participants is stopped.
0	1	Stop Only communication with DP-Master (class 2) is possible.
1	0	Clear The master tries to set parameters, check configuration and perform data exchange with its associated DP-slaves; the slaves' inputs are transferred to the input buffer, their outputs are cleared.
1	1	Operate The master exchanges data with the assigned DP-slaves.

**Note**

The network state will be Offline when a P-DP H/W failure is detected (IR n+2.06 is ON) or when a database download is in progress.

**IR n+3** This IR word contains information about the PROFIBUS-DP error status.

IR n+3 will indicate the error type and the station address of the station that is in error. If more than one station is in error, it will report on the first station that is detected to be in error. After removing the cause of the error it will report on the next station that was found in error. If the error is in the master itself, the Station address will show the value FFh.

The following table lists the error types.

Station address	Error number	Cause	Action
any	00h	No errors	
≠FFh	03h	Function in slave is not activated	Check if the slave is conform PROFIBUS-DP norm and that the correct GSD files are used
	11h	No response of the slave	Check the bus cable and the station address of the remote node
	12h	The Master is not into the logical token ring	Check the node address of the master and the highest station address of other master systems. Check if the cables are connected properly.
FFh	36h 38h D4h	Error in configuration data	Download the configuration again
	BE	Bus errors detected	Check the bus connections and cabling.
	other	Unit fault	Try downloading the configuration again; if the same error occurs, replace the Unit

**Note** When the PROFIBUS hardware does not function properly (P-DP H/W failure, IR n+2.06 bit is ON), the contents of this word is set to 0.

**IR n+4** **Unit Number and Message Length**

When IR n+2.13 is set (Reply in output mailbox), this IR word contains the length of the message that can be retrieved with an IORD instruction. Combined with the Unit number, this constitutes the correct source information for the IORD instruction. Refer to section 6-3 for more details about the IORD instruction.

**Note** When the PROFIBUS hardware does not function properly (P-DP H/W failure, IR n+2.06 bit is ON), the contents of this word is set to 0.

**Slave status**

The 16 words that contain the slave status bits are shown below. The location of these words in the PLC’s memory depends on the settings in DM m+14 and m+15 (see 5-1-2). Default location is IR 200 ~ 215.

These words only indicate the status of the slaves that have been assigned to the respective master Unit and thus possibly not of all slaves in the network.

word	bit 15	14	13	12	11	10	9	8	7	6	5	4	3	2	1	0	
0	15	14	13	12	11	10	09	08	07	06	05	04	03	02	01		Active flags stations 01 ~ 15
1	31	30	29	28	27	26	25	24	23	22	21	20	19	18	17	16	Active flags stations 16 ~ 31
2	47	46	45	44	43	42	41	40	39	38	37	36	35	34	33	32	Active flags stations 32 ~ 47
3	63	62	61	60	59	58	57	56	55	54	53	52	51	50	49	48	Active flags stations 48 ~ 63
4	79	78	77	76	75	74	73	72	71	70	69	68	67	66	65	64	Active flags stations 64 ~ 79
5	95	94	93	92	91	90	89	88	87	86	85	84	83	82	81	80	Active flags stations 80 ~ 95
6	111	110	109	108	107	106	105	104	103	102	101	100	99	98	97	96	Active flags stations 96 ~ 111
7			125	124	123	122	121	120	119	118	117	116	115	114	113	112	Active flags stations 112 ~ 125
8	15	14	13	12	11	10	09	08	07	06	05	04	03	02	01		Diagnostic flags stations 01 ~ 15
9	31	30	29	28	27	26	25	24	23	22	21	20	19	18	17	16	Diagnostic flags stations 16 ~ 31
10	47	46	45	44	43	42	41	40	39	38	37	36	35	34	33	32	Diagnostic flags stations 32 ~ 47
11	63	62	61	60	59	58	57	56	55	54	53	52	51	50	49	48	Diagnostic flags stations 48 ~ 63
12	79	78	77	76	75	74	73	72	71	70	69	68	67	66	65	64	Diagnostic flags stations 64 ~ 79
13	95	94	93	92	91	90	89	88	87	86	85	84	83	82	81	80	Diagnostic flags stations 80 ~ 95
14	111	110	109	108	107	106	105	104	103	102	101	100	99	98	97	96	Diagnostic flags stations 96 ~ 111
15			125	124	123	122	121	120	119	118	117	116	115	114	113	112	Diagnostic flags stations 112 ~ 125

**Slave active bits**

The first 8 words comprise the ‘slave active’ flags. These indicate which of the slaves are active and are exchanging data with the master Unit. If a slave active flag is OFF (0), the corresponding slave is either not configured, or not exchanging data.

It is recommended to use the ‘slave active’ bit as a condition in the PLC program for processing the slave’s input data. If the ‘slave active’ bit is OFF, the presented input data may not be valid.

**Slave diagnostic bits**

The next 8 words comprise the ‘slave diagnostic’ flags. These indicate if slave diagnostic information is available from the corresponding slave station.

The master sets a flag when the diagnostic data sent by the slave does not contain all zeros. Diagnostic data that only contains zeros is considered as no diagnostics.

The diagnostic bit is also set when a configured slave fails to respond.

When the diagnostic bit is set, the corresponding diagnostic data can be retrieved by sending a ‘request for diagnostics’ command to the output mailbox with an IOWR instruction. The corresponding reply can be read from the input mailbox with an IORD instruction (see section 6 for command transfer by IOWR / IORD). The diagnostic bit is reset after the request, but if the cause for diagnostics is persistent, the diagnostic bit will remain ON.

**Note** The contents of these status words are cleared during the initialisation after start-up, during a download of a new configuration and when the PROFIBUS hardware does not function properly (P-DP H/W failure, IR n+2.06 bit is set).

## 5-4 LEDs

The Unit has six LEDs to visualise its status. The layout of the LEDs is shown below.

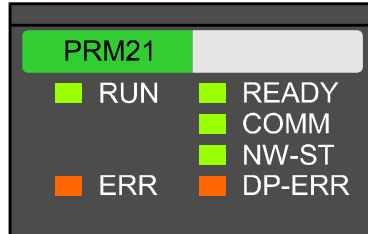

The two LEDs on the left side (RUN, ERR) show the status of the Unit in general. The four LEDs on the right side indicate the status of the PROFIBUS-DP network.

The different states of the LED are listed in the table below. The following flowchart describes the sequence in which the LEDs are turned ON or OFF.

In some states additional information is indicated by the status word IR n+2 and IR n+3. The flowchart and the table refer to this status word where applicable.

### Unit status LEDs

LED	Colour	State	Description
RUN	Green	OFF	Fatal error detected
		Flashing	Initialising the hardware / software
		ON	The Unit is initialised and no fatal error is detected
ERR	Red	OFF	No errors
		Flashing	Non-fatal error due to incorrect Unit settings Details in IR n+2.09, n+2.10
		ON	Fatal error. Details in IR n+2, bits 06 through 08

**PROFIBUS-DP status LEDs** (only valid when RUN LED is ON)

LED	Colour	State	Description
READY	Green	OFF	PROFIBUS-DP fatal error
		Flashing	Configuration download in progress IR n+2.14 and IR n+2.15 are OFF (Offline)
		ON	The Unit is ready to communicate.
COMM	Green	OFF	The master does not get any positive reply back from the slaves during the polling procedure. No I/O data is being exchanged with DP-slaves.
		ON	The master does get at least one positive reply back from one of the slaves in the network. This does not automatically mean that I/O data is being exchanged!
NW-ST	Green	OFF	Network state is Offline or Stop IR n+2.14 = 0
		Flashing	Network state is Clear IR n+2.14 = 1, IR n+2.15 = 0
		ON	Network state is Operate IR n+2.14 = 1, IR n+2.15 = 1
DP-ERR	Red	OFF	No PROFIBUS-DP specific errors and no fatal PLC error detected.
		Flashing	At least one of the DP slaves is in error or is not configured correctly (See also IR n+2.02, n+2.03).
		ON	Configuration error is detected, RUN LED or READY LED is flashing (see also IR n+3). Download the configuration again.

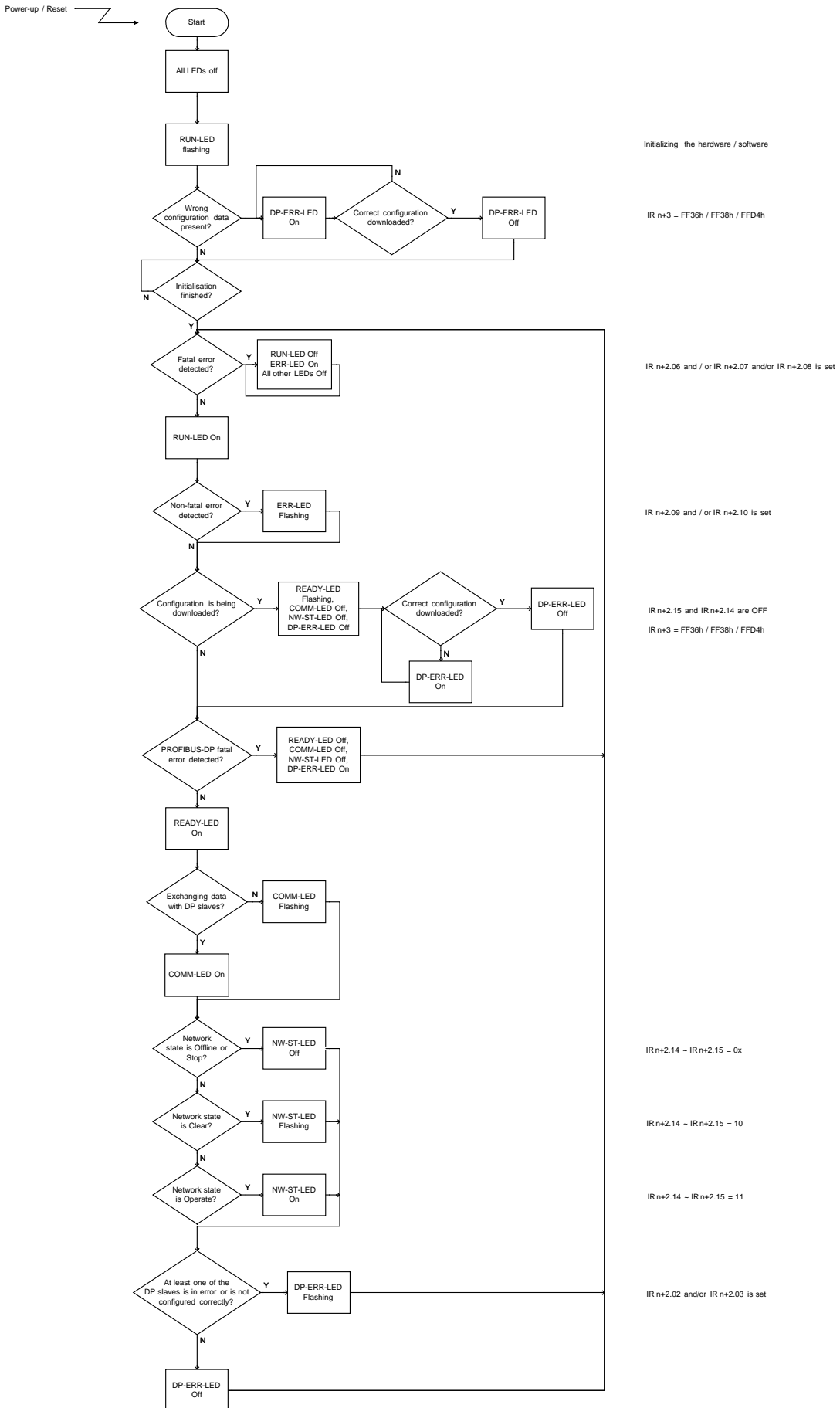



## 6 Message Communication, IOWR / IORD

This section describes the message communication. The PLC program instructions IOWR and IORD are used to transfer the messages to and from the Unit.

6-1 Message communication .....	74
6-2 IOWR.....	74
6-3 IORD.....	76
6-4 Messages .....	77
6-4-1 Control command.....	78
6-4-2 Slave diagnostics .....	79

## 6-1 Message communication

- Mailboxes** The Unit handles the message communication via the Input and Output mailbox. These mailboxes are described in section 5-2.
- Control words** The control words (see 5-3-1) can be used to send standard messages, i.e. PROFIBUS control commands. The IOWR instruction can be used to send any fieldbus-specific message. The advantage of this method is that the Unit will be able to handle future upgrades of fieldbus message types.
- IOWR** The Input mailbox will contain responses to commands sent out via the Output mailbox. The Unit will automatically remove responses to control commands as they do not contain any valuable information. Responses to other commands sent with the IOWR instruction, have to be read with an IORD instruction to prevent filling up of the Input mailbox.
- IORD** The transfer of messages via the control words is described in section 5-3-1. This section will describe the transfer of messages via IOWR / IORD.

**Note** The transfer of messages with IOWR and IORD is only supported by the C200HE, C200HG, C200HX and CS1 PLC's, not by the C200HS.

## 6-2 IOWR

The ladder symbols for IOWR are shown below.

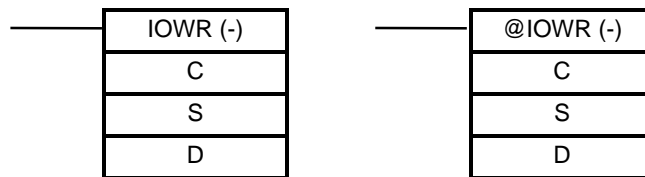

- C** Control code  
value: #0000
- S** First source word  
value: The address of the first word of the PLC data area that contains the message to be transferred to the Output mailbox.
- D** Destination information  
value: Combination of the Unit number of the Master Unit and the message length (number of words in BCD).

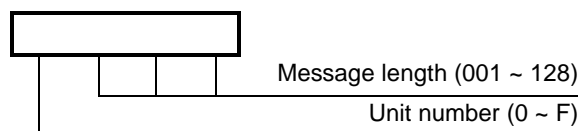

**Output mailbox full** The IOWR instruction should not be executed unconditionally. The Output mailbox is not always able to receive and process a new message. Status bit IR n+2.12 indicates the status of the Output mailbox at the moment of the last I/O refresh (1 = Output mailbox full). It is good practice to only execute the IOWR instruction when IR n+2.12 is not set. It should be noted that this IR bit is only updated during the I/O refresh and thus the status of this bit is not valid anymore after executing an IOWR instruction in the PLC program. Therefore it is recommended not to execute the IOWR instruction more than once per PLC cycle.

**EQ-flag** The EQ-flag in the PLC will indicate the result of execution of the IOWR instruction. If this flag is set, the message was transferred successfully to the Output mailbox. If this flag is not set, either the Output mailbox was full, or the RUN-bit (IR n.00) was not set, or the DP communication was disabled (IR n.01). In all cases the message was not transferred to the Output mailbox. It is advised to always check the EQ-flag.

**ER-flag** The ER-flag in the PLC will report on syntax errors made in the IOWR instruction itself. It is not necessary to check this flag; if a syntax error is made, the EQ-flag will also indicate that the transfer was not successful.

**Example** An example of the use of the IOWR instruction is shown below.

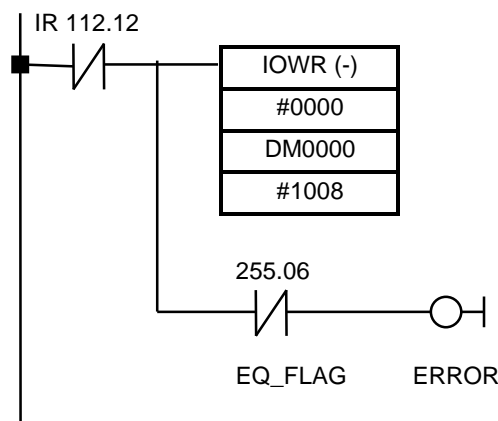

In the example above, the Unit number setting is assumed to be '1'. The IOWR instruction is only executed when the 'Output mailbox full' bit is not set. It transfers 8 words starting from DM0000 to the Output mailbox of the Master Unit with Unit setting 1. The ERROR output bit is set when the IOWR transfer was not successful.

### 6-3 IOR

The ladder symbols for IOR are shown below.

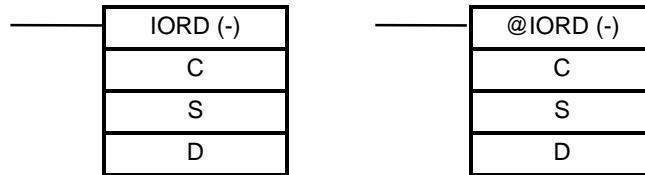

- C** Control code  
value: #0000
- S** Source information  
value: Combination of the unit number of the Master Unit and the message length (number of words in BCD).  
IR n+4 can be used as source information. If a message is posted in the input mailbox, this IR word will contain the correct information for retrieval of the full message.

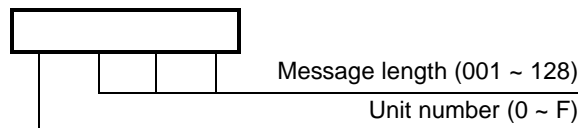

- D** First destination word  
value: The address of the first word of the PLC data area to where the message from the Input mailbox is to be transferred.

**Reply in input mailbox**

The IOR instruction should not be executed unconditionally. IOR should only be executed when there is a reply message in the Input mailbox. The status of the Input mailbox is indicated by status bit IR n+2.13 (Reply in input mailbox). If this bit is set, an IOR instruction should be executed to remove the response from the Input mailbox. This will prevent the Input mailbox from filling up.

**Input mailbox clear**

An IOR instruction should not be executed in the PLC cycle after an 'Input mailbox clear' command is issued. As the 'Input mailbox clear' command (IR n.02) will not be executed until after the I/O refresh, the status of IR n+2.13 will be updated in the next I/O refresh.

It is not recommended to execute two IOR instructions per PLC cycle because the status of IR n+2.13 is not valid anymore after executing the first IOR instruction.

**EQ-flag**

The EQ-flag in the PLC will indicate the result of execution of the IOR instruction. If this flag is set, the message was transferred successfully from the Input mailbox to the specified PLC data area. It is advised to always check this flag, especially in the cases described above when an 'Input mailbox clear' command has been issued, or when more than one IOR instruction is programmed to be executed in one PLC cycle.

**ER-flag**

The ER-flag in the PLC will report on syntax errors made in the IOR instruction itself. It is not necessary to check this flag; if a syntax error is made, the EQ-flag will also indicate that the transfer was not successful.

**Example**

An example of the use of the IORD instruction is shown below.

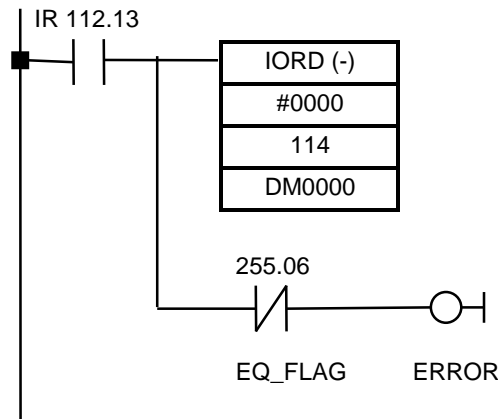

In the example above the Unit number setting is assumed to be '1'. The IORD instruction is only executed when the 'Reply in input mailbox' flag is set. IR 114 contains the correct source information. The IORD instruction transfers the oldest reply from the Input mailbox to the PLC, starting at DM0000. The ERROR output bit is set when the IORD transfer was not successful. This could be because of a syntax error in the IORD instruction or because there was no reply in the Input mailbox anymore.

## 6-4 Messages

**Fixed format**

Messages to be sent to the Output mailbox and received from the Input mailbox have a fixed format. The command and the response are according the following format.

Type	Size (words)	Description
Message header	4	Defines the sender, receiver, command type and the total length of the telegram. It is also possible to give a unique number to each message.
Telegram header	0 ~ 4	Detailed definition of the command message
Telegram data	0 ~ 124	Message data

**Max. length**

The overall length of the message is limited to 128 words (limitation of the IOWR / IORD instruction). Every message has a message header, but not all messages have a telegram header or telegram data. In messages without a telegram header, the length of the telegram data can be up to 124 words. With a telegram header, the length can only be up to 120 words.

**Command types**

The two types of command message presently supported are:

1. Control command
2. Slave diagnostics

These commands are described in more detail in the next two sub-sections.

### 6-4-1 Control command

This command can also be issued via the control words (see section 5-3-1).  
The message for a control command is shown below.

	MSB	LSB
word n	03h	10h
word n+1	03h	00h
word n+2	00h	00h
word n+3	46h	00h
word n+4	Station address (00h ~ 7Fh)	Control command
word n+5	Group select (00h ~ FFh)	00h

The message consists of 6 words which have to be prepared in a PLC data area.

Station address and Group select are described in the paragraph on control word IR n+1 (see section 5-3-1).

The settings in the Control command byte define which control command is to be sent; see table below.

Bit	Command	Meaning
0	-	-
1	Clear_Data	Clear output data
2	Unfreeze	Unfreeze input data
3	Freeze	Freeze input data
4	Unsync	Unsynchronise output data
5	Sync	Synchronise output data
6	-	-
7	-	-

#### Command priority

When issued simultaneously, Unsync has priority over Sync, and Unfreeze has priority over Freeze.

The Clear\_Data command will always clear the output data, independent whether the Freeze command is activated or not.

#### No response message

The response message does not contain any valuable information and is therefore removed from the Input mailbox automatically. It is not necessary to issue an IORD command.

### 6-4-2 Slave diagnostics

The message for a slave diagnostics command is shown below.

	MSB	LSB
word n	03h	10h
word n+1	08h	Message number
word n+2	00h	00h
word n+3	42h	00h
word n+4	Station address (01h ~ 7Dh)	00h
word n+5	00h	00h
word n+6	00h	20h
word n+7	05h	01h

The message consists of 8 words which have to be set in a PLC data area.

**Message number**

The message number can be any number that can be formed by one byte. It enables to give the message a unique number. The response message will also have this number. In this way it is possible to keep track of which response message belongs to which command message.

**Station address**

The diagnostics can only be retrieved from one slave at a time. The station address (hex) of that slave must be entered in high byte of the fifth word.

**Note** Only request diagnostics of a station of which the diagnostics bit is set. Only then the data in the response message is valid. The data is most up to date just after the bit has been set.

**Response message**

The structure of the response message to a 'get diagnostics' command message is shown below. The response message is located in the Input mailbox and can be read with the IORD instruction.

	MSB	LSB
word n	10h	03h
word n+1	Length of the message starting from word n+2 [bytes]	Message number
word n+2	42h	Command error if ≠00h
word n+3	00h	00h
word n+4	Station address	00h
word n+5	00h	00h
word n+6	00h	Length of the message starting from word n+8 [bytes]
word n+7	05h	01h
word n+8	Station_status_1	Station_status_2
word n+9	Station_status_3	Master address
word n+10	Ident_Number (high byte)	Ident_Number (low byte)
word n+11	Extended diagnostic data 0	Extended diagnostic data 1
word n+12	Extended diagnostic data 2	Extended diagnostic data 3
word n+127	Extended diagnostic data 232	Extended diagnostic data 233

<b>Error message</b>	<p>There are two types of responses. The response can either be an answer message to the issued command or an error message.</p> <p>The error message occurs due to a syntax error in the command message. In this case the low byte of word n+2 will be unequal to zero to indicate the error; the values of the other words should not be considered valid.</p>
<b>Note</b>	<p>If bit IR n+2.13, 'Reply in input mailbox', does not get set after issuing the request for slave diagnostics with the IOWR instruction, the command message in the PLC data area is not correct.</p> <p>The slave diagnostic bit will only get set when the extended diagnostic data does not contain all zeros <i>or</i> when the slave is noted as not being existent.</p> <p>The lower byte of word n+6 contains the exact length in bytes of the message starting from word n+8. This represents the actual diagnostic data received from the slave. The maximum data length is 244 (F4h).</p>
<b>Extended diagnostics</b>	<p>The data starting from word n+11 is slave specific, some slaves do not have extended diagnostic information. The first extended data byte has a fixed format and describes the type of diagnostics, the rest of the data bytes are slave specific. The slave manual should give information about the definition of the extended diagnostics.</p>
<b>Master address</b>	<p>The 'Master address' byte contains the address of the master which has parameterised the DP slave. If no master has parameterised the DP slave, the value of this byte is FFh.</p>
<b>Identifier</b>	<p>Word n+10 contains the manufacturer identifier of the DP slave, as registered at the Profibus Nutzerorganisation (PNO).</p>



**Station Status**

The definitions of word n+8, n+9 and n+10 are the same for all slaves. The following tables describe the definition of these words. For more details refer to EN 50170 Vol.2.

**Station\_status\_1**

Bit	Meaning
0	1: DP Slave station non existent
1	1: DP Slave station not yet ready for data exchange
2	1: Configuration data sent by DP master to DP slave does not match the structure of the DP slave
3	1: DP slave has extended diagnostic information
4	1: Requested function is not supported by DP slave
5	1: Implausible answer received from DP slave
6	1: Parameterisation telegram contains an error
7	1: DP slave was parameterised by a DP master other than the DP master which currently has access to the DP slave

**Station\_status\_2**

Bit	Meaning
0	1: DP Slave must be reparameterised
1	1: A diagnostic message is waiting. The DP slave cannot resume operation until the error has been rectified (static diagnostic message)
2	1: Bit is always '1' if DP slave having this station number exists
3	1: Response monitoring (watchdog) is activated for this slave
4	1: DP slave has received a 'Freeze' control command
5	1: DP slave has received a 'Sync' control command
6	1: Bit is always '0'
7	1: DP slave is deactivated, i.e. slave has been removed from current processing

**Station\_status\_3**

Bit	Meaning
0	reserved
1	reserved
2	reserved
3	reserved
4	reserved
5	reserved
6	reserved
7	1: More diagnostic information exists than specified in the extended diagnostic data.



# 7 Troubleshooting and Maintenance

This section describes the troubleshooting procedures and maintenance operations needed to keep the PROFIBUS-DP network operating properly

7-1 Error Indicators .....	84
7-2 Troubleshooting .....	84
7-3 Maintenance .....	90
7-3-1 <i>Cleaning</i> .....	90
7-3-2 <i>Inspection</i> .....	90
7-3-3 <i>Replacing Nodes</i> .....	91
7-3-4 <i>Adding Nodes</i> .....	91

## 7-1 Error Indicators

The Unit provides the following error indicators:

- The two red LEDs at the front of the Unit, ERR LED and DP-ERR LED
- The status words IR n+2 and IR n+3 which are transferred from the Unit to the PLC IR area every I/O refresh from the moment the Unit is initialised.

These indicators are described in section 5-3-2 and section 5-4.

## 7-2 Troubleshooting

Possible problems have been divided in the following categories:

- PLC Error
- Start-up problems
- Configuration problems
- I/O data communication problems
- Message communication problems

### PLC Error

Description	Possible cause	Possible remedy						
An I/O verification error occurred.	The current PLC configuration is not the same as it was when the I/O table was registered.	Check the I/O table with the I/O table verification operation and correct it if necessary. After correcting it, perform the I/O Table Create operation.						
An I/O Unit Over error occurred.	The Master's Unit number setting is incorrect.	<p>Make sure that the unit number setting does not exceed the maximum possible unit number.</p> <table border="1"> <thead> <tr> <th>CPU Unit models</th> <th>Max Unit number</th> </tr> </thead> <tbody> <tr> <td>C200HS-series C200HE-CPU11/32/42 C200HG-CPU33/43 C200HX-CPU34/44</td> <td>9</td> </tr> <tr> <td>C200HG-CPU53/63 C200HX-CPU54/64 CS1-series</td> <td>F</td> </tr> </tbody> </table> <p>If it does exceed the limit, adjust the Unit number and restart the Unit.</p>	CPU Unit models	Max Unit number	C200HS-series C200HE-CPU11/32/42 C200HG-CPU33/43 C200HX-CPU34/44	9	C200HG-CPU53/63 C200HX-CPU54/64 CS1-series	F
	CPU Unit models	Max Unit number						
C200HS-series C200HE-CPU11/32/42 C200HG-CPU33/43 C200HX-CPU34/44	9							
C200HG-CPU53/63 C200HX-CPU54/64 CS1-series	F							
	Two units claim the same unit number.	Adjust the Unit number and restart the Unit.						
A Special I/O Unit error occurred.	The Unit is not connected properly or was removed while the power was ON.	Turn the power OFF an check that the Unit is connected properly and turn the power ON again.						
An I/O Bus error occurred.	The Unit is not connected properly.	Turn the power OFF an check that the Unit is connected properly and turn the power ON again.						
	The Master Unit is faulty	Replace the Master Unit.						

Start-up problems

Description	Possible cause	Possible remedy
No LEDs are ON or Flashing	The PLC's power is OFF	Turn the PLC's power supply ON.
	The Master Unit is faulty.	Replace the Master Unit.
The RUN LED is Flashing	The same unit number has been set on another Special I/O Unit, causing an I/O UNIT OVER error in the PLC.	Make sure that the same unit number is not used by more than one Special I/O Unit and restart the PLC.
	I/O table verification error. A Unit has been removed or the Unit number setting has been changed that caused an I/O SET ERR error in the PLC.	Verify the I/O table and/or register the I/O table again.
	A Special I/O Unit or Interrupt Input Unit has not been initialised, causing an CPU WAIT'G error in the PLC.	Check and/or remove the faulty Unit.
	The Master Unit is faulty	Replace the Master Unit.
The DP-ERR LED is ON and the RUN LED is Flashing	Wrong configuration data is present in the Unit. The Unit waits for a configuration to be downloaded.	Download a configuration.
	The Master Unit is faulty.	Replace the Master Unit.
ERR LED is ON	A fatal error is detected. The cause is reported in IR n+2.06 ~ IR n+2.08	Try to solve the cause and / or restart the Unit. If this does not help, replace the Master Unit

Configuration problems

Description	Possible cause	Possible remedy
Downloaded a configuration, but the DP-ERR LED is flashing.	Configuration is incorrect. IR n+2.03 is ON.	Check IR n+3 to find out where / what the possible problem is. Check if the configuration corresponds to the actual network configuration. Do the DP-slaves have the same station addresses as in the configuration? Are the correct GSD-files being used? If all is correct, try to download it again. If the error remains, try to find out what is going on with the configurator debugger.
DP-ERR LED is ON and the READY LED is flashing	Erroneous configuration data is present in the Unit. The Unit waits for a configuration to be downloaded	Download a configuration.
Configurator does not download the configuration.	Faulty RS-232C connection.	Check if the connection between the computer and the Master Unit is correct. Check if the cable is connected to the configured COM-port.
	COM-port driver not set up or wrong COM-port configured.	Check if the driver is configured to the correct COM-port.

**Configuration problems (continued)**

<b>Description</b>	<b>Possible cause</b>	<b>Possible remedy</b>
READY LED is flashing	The Master Unit is faulty.	Try to restart the Unit and do another download. If this does not work, replace the Unit.
ERR LED is ON	A fatal error is detected. The cause is reported in IR n+2.06 ~ IR n+2.08	Try to solve the cause and / or restart the Unit. If this does not help, replace the Unit

**I/O data communication problems**

<b>Description</b>	<b>Possible cause</b>	<b>Possible remedy</b>
COMM LED is OFF	The wiring is not correct.	Check IR n+3 to find out where / what the possible problem is. Check if the correct pins of the BUS connector are connected, if there are no short circuits, if the stub-lines are not too long.
	The network has not been terminated correctly.	Terminate the network at the appropriate places (see section 2-3-1).
	Configuration is not correct.	Check IR n+3 to find out where / what the possible problem is. Check if the DP-slaves have the same station address as in the configuration. Check if no station address is used twice. Check that all masters in the same network have been configured to the same baud rate. Check if the correct GSD-files are being used. Check that the bus parameters have the correct value. It is recommended to use the default bus parameters (e.g. HSA must be greater or equal to the highest master node address in the network). After changing the configuration, download the configuration to the respective Master Unit.
	The DP-communication is inhibited. The control bit IR n.01 of the control words is set.	Reset the control bit IR n.01
	The Master Unit is faulty	Replace the Master Unit.

I/O data communication problems (continued)

Description	Possible cause	Possible remedy
<p>COMM LED is ON but DP-ERR LED is flashing</p>	<p>The wiring is not correct.</p>	<p>Check IR n+3 to find out where / what the possible problem is. Check if the correct pins are connected, if there are no short circuits, if the stub-lines are not too long.</p>
	<p>Configuration is not correct.</p>	<p>Check IR n+3 to find out where / what the possible problem is. Check if the DP-slaves have the same station address as in the configuration. Check if no station address is used twice. Check that all masters in the same network have been configured to the same baud rate. Check if the correct GSD-files are being used. Check that the bus parameters have the correct value. It is recommended to use the default bus parameters (e.g. HSA must be greater or equal to the highest master node address in the network). After changing the configuration, download the configuration to the respective Master Unit.</p>
	<p>The Master Unit is faulty</p>	<p>Replace the Master Unit.</p>
<p>No I/O data is exchanged with the PLC though the COMM LED is ON</p>	<p>The I/O data mapping has been defined at the wrong PLC data area.</p>	<p>Make sure that the Unit settings are made in the correct DM memory area; the area depends on the unit number setting.</p>
	<p>The I/O data mapping contains errors that caused that certain or no data areas to be mapped at all. The ERR LED is Flashing.</p>	<p>Check the Unit settings. IR n+2.09 and IR n+2.10 of the status words indicates what caused the error.</p>
	<p>The Run bit (IR n.00) is OFF</p>	<p>Set the Run bit IR n.00 ON.</p>
	<p>Another Special I/O Unit makes use of the same data area(s).</p>	<p>Check the mapping of the Master Unit and the other Special I/O Unit. If they overlap, then one Unit overwrites the data area of the other Unit and makes it look like that no data is being exchanged with the PLC. If an overlap exists, the Unit settings should be changed.</p>
	<p>The Master Unit is faulty</p>	<p>Replace the Master Unit.</p>
<p>I/O data does not seem to get exchanged with a specific slave</p>	<p>Slave is not connected properly.</p>	<p>Check IR n+3 to find out where / what the possible problem is. Check if the slave is connected properly. Are the correct pins connected, Is the shield also connected, is the bus length not exceeded?</p>
	<p>The slave operates in 'Sync' / 'Freeze'-mode.</p>	<p>In these modes, the data is only updated after another transmission of the 'Sync' / 'Freeze' command. If this is not desired, these modes should be turned OFF. See section 5-3-1 for more details.</p>
	<p>The master or the transmission line has failed, the watchdog of the slave has switched the outputs of the slave to the fail-safe state.</p>	<p>Check the transmission line and master Unit or disable the slave's watchdog (not recommended).</p>
	<p>Slave Unit is faulty.</p>	<p>Replace the Slave Unit.</p>

I/O data communication problems (continued)

Description	Possible cause	Possible remedy
Outputs are being reset.	Run bit (IR n.00) is OFF. This can be due to a fatal PLC error or due to a mode change to / from PROGRAM mode.	Check if the PLC is in PROGRAM mode, or if a fatal PLC has occurred. Find the cause of the fatal error, set IR n.00 ON and operate the outputs.
	IR n+2.02 set? If so, the 'Data_Control_Timer' of one of the slaves has expired and the 'Auto_clear' is enabled. The master has entered the network state 'Clear'. (see for more details section 1-4-4)	Check IR n+3 to find out where / what the possible problem is. Fix or remove the slave that caused the master to enter the 'Clear' state or disable the 'Auto_clear' mode (see section 4-3-7)
	The master or the transmission line has failed, the watchdog of the slave (if enabled) has switched the outputs of the slave to the fail-safe state.	Check the transmission line and master Unit or disable the slave's watchdog (not recommended).
	The PLC cycle time is greater than the configured watchdog time of the slave which results in expiration of the watchdog in the synchronous mode. This switches the outputs to the fail-safe state.	Increase watchdog time or decrease PLC cycle time or choose asynchronous mode.
	The Master Unit is faulty.	Replace the Master Unit.
Outputs do not change anymore	Run bit (IR n.00) is OFF. This can be due to a fatal PLC error or due to a mode change to / from PROGRAM mode, with DM m+17 = 1 (hold mode).	Check if the PLC is in PROGRAM mode, or if a fatal PLC has occurred. Find the cause of the fatal error, set IR n.00 ON and operate the outputs.
	Program execution has stopped due to a fatal PLC error or PLC is in PROGRAM mode and DM m+17 = 1	Check if the PLC is in PROGRAM mode or if a FALS error was generated.
	The slave operates in 'Sync'-mode.	In this mode the data is only updated after another transmission of the 'Sync'-command. If this is not desired, this mode should be turned OFF. See section 5-3-1 for more details.
	The Master Unit is faulty	Replace the Master Unit.
Inputs do not change anymore	Run bit (IR n.00) is OFF. This can be due to a fatal PLC error or due to a mode change to / from PROGRAM mode.	Check if the PLC is in PROGRAM mode, or if a fatal PLC has occurred. Find the cause of the fatal error, set IR n.00 ON and check the outputs.
	The slave operates in 'Freeze'-mode.	In this mode the data is only updated after another transmission of the 'Freeze'-command. If this is not desired, this mode should be turned OFF. See section 5-3-1 for more details.
	The Master Unit is faulty	Replace the Master Unit.
ERR LED is switched ON	A fatal error is detected. The cause is reported in IR n+2.06 ~ IR n+2.08	Try to solve the cause and / or restart the Unit. If this does not help, replace the Master Unit



Message Communication problems

Description	Possible cause	Possible remedy
IOWR instruction not successfully executed	Output mailbox is full. The Output mailbox is not able to process new command messages when the Input mailbox is not able to receive reply messages.	Clear the messages in the Input mailbox to enable the Input mailbox to receive new messages and the Output mailbox to process new messages. The messages can be cleared by using IORD instructions or by setting IR n.01 of the control words.
	The RUN-bit (IR n.00) is not switched ON or the communication is inhibited (IR n.01)	Set the RUN-bit and enable communication again.
	The IOWR instruction contains syntax errors	Check the IOWR instruction. Is the correct Unit number and message length specified?
	The transferred command message is not correct. <b>Note:</b> This error can not be detected by the result of the EQ-flag!	Check the command message that is created in the PLC data area. Does it comply with the command messages definition specified in section 6-4?
	The Master Unit is faulty	Replace the Master Unit.
IORD instruction not successfully executed	There is no reply message in the Input mailbox	Only read a message when IR n+2.13 (Reply in input mailbox) is set.
	The IORD instruction contains syntax errors	Check the IORD instruction. Are the correct Unit number and message length specified?
	The Master Unit is faulty	Replace the Master Unit.
Command was not successfully executed though IR n+2.12 (Output mailbox full) is not set.	Issued more than one IOWR per PLC scan or issued an IOWR after issuing a control command via the control words in the previous PLC scan. In both cases, IR n+2.12 has not been updated and the mailbox could just have been filled up and be unable to process more.	Do not issue more than one IOWR per PLC scan or do not issue an IOWR after issuing an control command via the control words in the previous PLC scan.
	For other reasons see situation 'IOWR instruction not successfully executed'	-
IORD command was not executed successfully though IR n+2.13 (Reply in input mailbox) was set.	Issued more than one IORD per PLC scan or issued an IORD after issuing an 'Input mailbox clear' command via the control words in the previous PLC scan. In both cases IR n+2.13 has not been updated and the Input mailbox could just have been cleared.	Do not issue more than one IORD per PLC scan or do not issue an IORD after issuing an 'Input mailbox clear' command via the control words in the previous PLC scan.
	For other reasons see situation 'IORD instruction not successfully executed'	-
ERR LED is switched ON	A fatal error is detected. The cause is reported in IR n+2.06 ~ IR n+2.08	Try to solve the cause and / or restart the Unit. If this does not help, replace the Master Unit

## 7-3 Maintenance

This section describes the routine cleaning and inspection recommended as regular maintenance.

### 7-3-1 Cleaning

Clean the PROFIBUS-DP Master Units regularly as described below in order to keep it in its optimal operating condition.

- Wipe the Unit with a dry, soft cloth for regular cleaning.
- When a spot cannot be removed with a dry cloth, dampen the cloth with a neutral cleanser, wring out the cloth, and wipe the Unit.
- A smudge may retain on the Unit from gum, vinyl, or tape that was left on for a long time. Remove the smudge when cleaning.

 **Caution** Never use volatile solvents such as paint thinner or benzene or chemical wipes. These substances could damage the surface of the Unit.

### 7-3-2 Inspection

Be sure to inspect the system periodically to keep it in its optimal operating condition. In general, inspect the system once every 6 to 12 months, but inspect more frequently if the system is used with high temperature or humidity or under dirty / dusty conditions.

#### Inspection Equipment

Prepare the following equipment before inspecting the system.

##### Required Equipment

Have a standard and Philips-head screwdriver, multimeter, alcohol, and a clean cloth.

##### Equipment that could be needed

Depending on the system conditions, a synchroscope, oscilloscope, thermometer, or hygrometer (to measure humidity) might be needed.

#### Inspection Procedure

Check the items in the following table and correct any items that are below standard.

	Item	Standard	Equipment
Environmental conditions	Ambient temperature	0°C to 55°C	Thermometer
	Ambient humidity	10% to 90%	Hygrometer
	Dust/dirt accumulation	None	---
Installation	Are the Units installed securely?	No looseness	---
	Are the communications connectors fully inserted?	No looseness	---
	Are the external wiring screws tight?	No looseness	---
	Are the connecting cables undamaged?	No damage	---

### **7-3-3 Replacing Nodes**

#### **Replacing on the fly**

Except for the Master Unit, all PROFIBUS-DP nodes can be replaced on the fly; the only condition is that the node is of the same type. Also, the network can be expanded with another Master Unit and its assigned slaves in full operation.

The Master Unit can only be replaced when the PLC power is turned OFF. After replacing the Unit, turn ON the power again and download the same configuration as was downloaded in the replaced Master Unit. Make sure that the Unit number setting is the same as the previous Master Unit. During replacement of the Master Unit the network is not operational.

#### **Precautions**

Observe the following precautions when replacing a Unit.

- After replacement make sure that there are no errors with the new Unit.
- When a Unit is being returned for repair, attach a sheet of paper detailing the problem and return the Unit to your OMRON dealer.
- If there is a faulty contact, try wiping the contact with a clean, lint-free cloth dampened with alcohol.

### **7-3-4 Adding Nodes**

#### **Download new configuration**

The PROFIBUS-DP network allows to add new nodes on the fly. After connecting the new node to the network, a new configuration which contains this new node must be downloaded to the Master. During the download, all bus activities are stopped.



# Appendix A

## Tips and sample programs

Unless indicated otherwise, all shown examples assume that:

- Machine No. switch of the C200HW-PRM21 is set to 0.
- All unit settings are at the default value (0000).
- Slaves are mapped into the unit's I/O buffers by auto-addressing (start at offset=0)

Therefore:

- Unit settings area is DM1000-1017.
- Command/status data are IR100-104.
- Remote inputs are IR350-399.
- Remote outputs are IR050-099.
- Slave status area is IR200-215.



## A.1. General guidelines on input data processing

The C200HW-PRM21 must be activated by setting the RUN bit (100.00) ON. It is recommended to always set this bit ON whenever the PLC program runs. If the PLC is set to PROGRAM mode, or the program stops due to a severe failure (FALS), this bit will turn OFF. If the unit detects this, it will Hold or Clear all slave output data, depending on the setting of DM 1017 (default = Clear, i.e. remote outputs are turned OFF like local outputs).

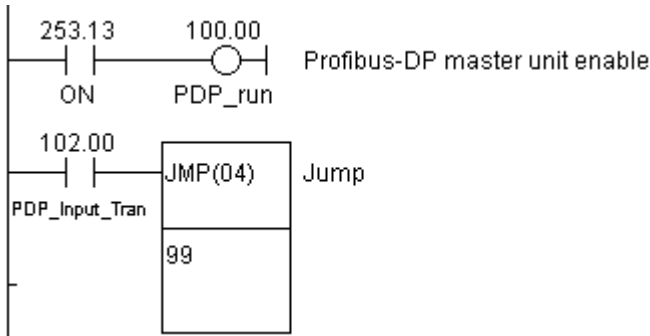

Bit 102.00 indicates if the Master Unit transferred input data from its buffer to the mapped input area in the PLC memory. In case the PLC cycle time is shorter than the bus cycle time this may not always be the case. In case no new data is available, processing of slave data may be skipped. If 102.00 is OFF, the ladder program between the JUMP instruction and the corresponding JME instruction will be skipped.

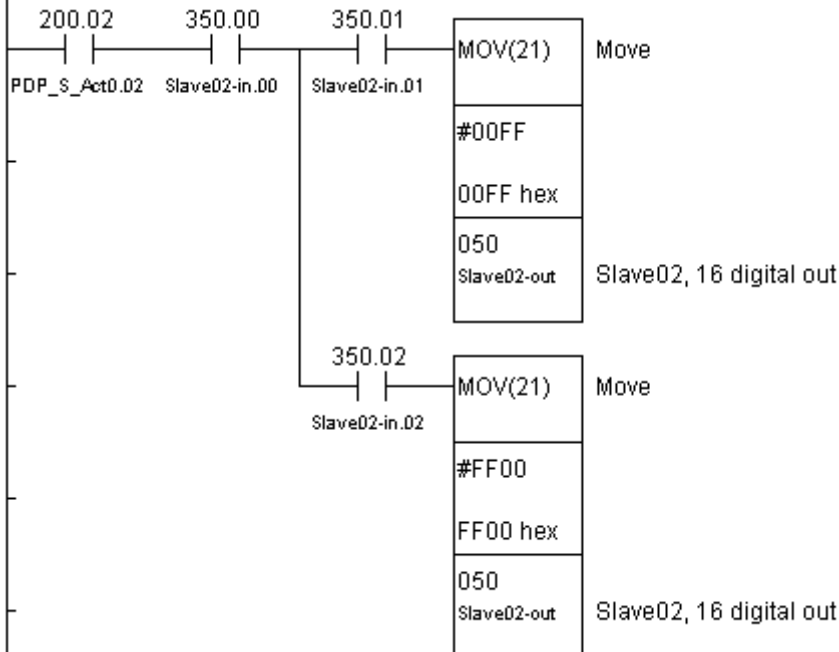

Before processing input data from a PROFIBUS slave, it is recommended to verify the corresponding 'slave active' bit. If the slave is not exchanging data with the master, the data in the allocated input area may be invalid, and should not be processed.

In this case, 200.02 is the slave active bit of the slave with address 02, whose inputs are mapped to IR350, and outputs to IR050.

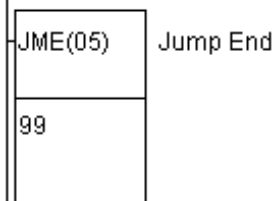

This JME instruction signifies the end of the PROFIBUS slave input data processing. The program will continue here following the JUMP command if no new input data was available (if 102.00 was OFF).

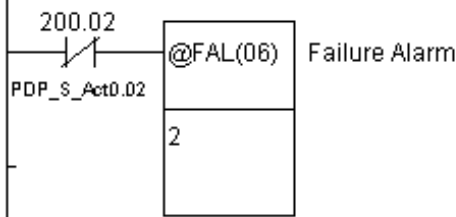

If a slave active bit turns OFF during operation, this signifies a communication breakdown or slave failure. In this case, an alarm is triggered. Depending on the severity of the failure, further emergency processing may be added by the user.





## A.2. Data exchange method: synchronous or asynchronous?

By setting DM 1016, the user may select to synchronise the PROFIBUS-DP bus cycle with the PLC cycle. If selected, each PLC I/O refresh the PROFIBUS-DP master will attempt to trigger a new fieldbus cycle. If the previous fieldbus cycle had not yet been completed, a new attempt will be made at the next I/O refresh.

The default setting is no synchronisation between PLC cycle and fieldbus cycle. In that case, fieldbus cycles are triggered autonomously, independent of the PLC cycle. All input data from the latest bus cycle is kept in a buffer for the PLC to access at I/O refresh time.

In general, it will be advantageous to select the asynchronous method if the PLC cycle time is considerably larger than the PROFIBUS cycle time. It will be better to choose synchronous mode when both cycles are in the same order of magnitude due to the additional buffering required in asynchronous mode.

Without additional tools it is difficult to determine the actual PROFIBUS-DP cycle time. The calculations in Chapter 2 will give a rough indication, but if the actual network is available, a measurement is more reliable. With the help of the sample program on the next page, it is possible to measure the cycle time in all but the most extreme cases, i.e. at very high baud rates with very few slaves. The method is based on automatic variation of the PLC cycle time to determine when input data is still refreshed each PLC scan.

### Determine PROFIBUS cycle time

1. Using the configurator software, build the desired bus configuration and download the corresponding configuration file into the C200HW-PRM21. The complete configuration needs to be connected and powered up.
2. Enter the sample program as shown on the next page in the PLC CPU.
3. Make the following settings in DM to achieve the minimum I/O refresh time, then restart the unit to activate these settings. (Note that the slave outputs will remain reset since no data is transferred from the PLC)

DM 1000	0001	One output area
DM 1003	0000	Output area size = 0
DM 1007	0001	One input area
DM 1008	0000	Input buffer offset = 0
DM 1009	A050	Start at IR 050
DM 1010	0001	Input area size is 1 word
DM 1016	0001	Synchronous data exchange

The PLC scan time will eventually settle on a fixed value.

If the value of DM 0000 falls to 0, the cycle time of PROFIBUS-DP is less than the minimum PLC cycle time that can be achieved. For any other value than 0, the PROFIBUS cycle time equals the PLC scan time MINUS the I/O refresh time. With the DM settings as above (1 I/O word transferred), the C200HW-PRM21's I/O refresh on C200H alpha series PLCs takes 1.4 ms, on C200HS 2.1 ms.

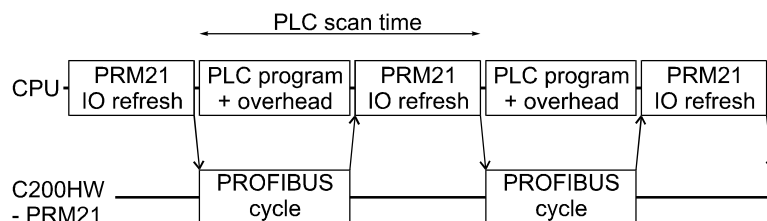

*Synchronous data transfer mode with PLC scan time fully adapted to PROFIBUS cycle time.*

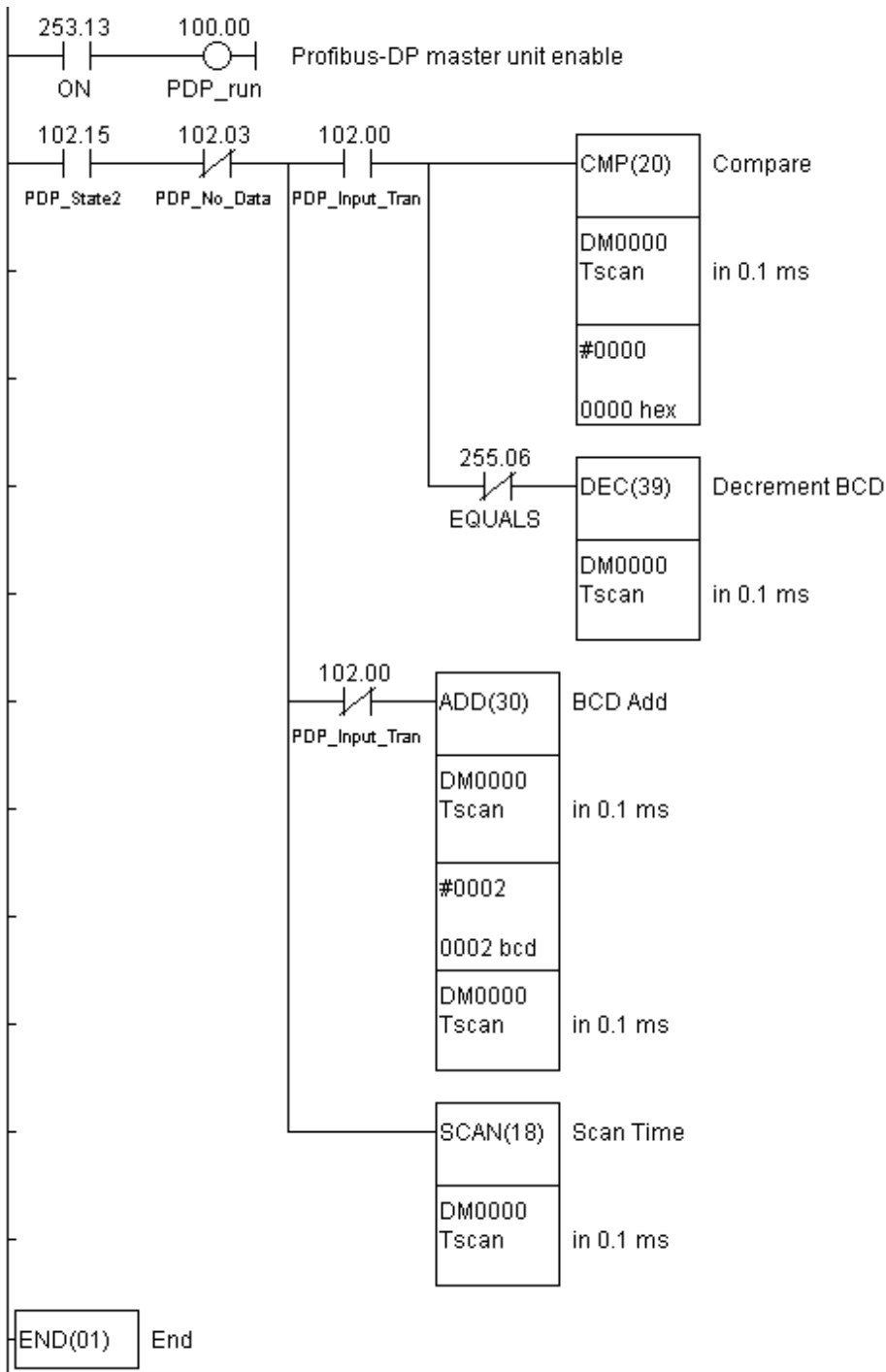

Activate the I/O data exchange.

Check if the unit is in Operate state (102.15 ON) and all slaves are in data exchange mode (102.03 OFF), then:

If new input data is received in the last I/O refresh (102.00 ON), the PLC scan time (set in DM0000) will be decreased by the minimum step size of 0.1 ms.

The scan time cannot be decreased below 0.0 ms

If no new data has been received during I/O refresh (102.00 OFF), the previous PROFIBUS cycle took longer than the PLC cycle. The PLC scan time is increased by 0.2 ms. It is essential that rate of increase is larger than the rate of decrease, in order to stabilise the process of approximation.

The value in DM0000 is set as scan time for the next PLC cycle.

Sample program to determine PROFIBUS-DP cycle time.

After determining the cycle time of the PROFIBUS-DP system, it is possible to establish the optimal data exchange method using the actual PLC application program.

## Actual application

Once the actual application program in the PLC has been completed, and the DM settings have been optimised to transfer only the data required for the application,

- Read the actual value of the PLC scan time from AR27 with the PLC in Run/Monitor mode.
- Calculate the C200HW-PRM21's I/O refresh time as shown in paragraph 3-2-2, 'PLC cycle time'.
- By subtracting these two figures, calculate the time required for the PLC program plus the overhead for servicing additional units and peripherals.

Only if the PROFIBUS-DP cycle is several times smaller than the time taken by the PLC program + overhead, choosing the asynchronous data exchange method will result in a consistent reduction of remote I/O response time.

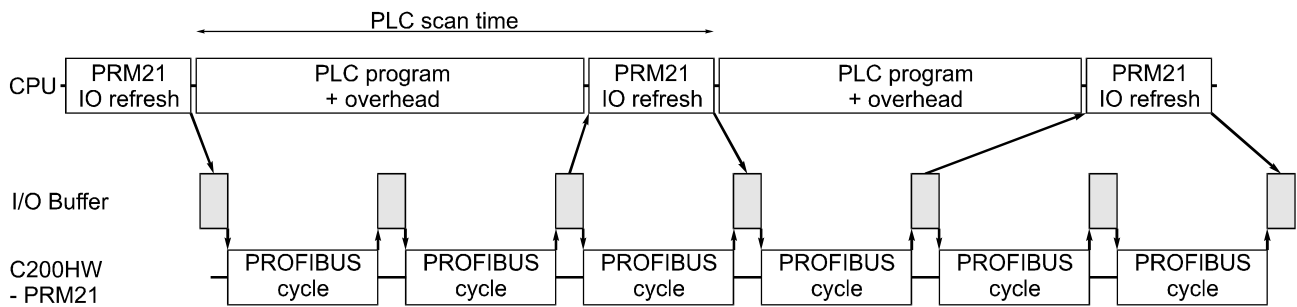

*Asynchronous data transfer mode with PLC program + overhead  $\approx 2 * PROFIBUS$  cycle.  
This will result in irregular data transfer, but data is updated at least once per PLC cycle.*



## Appendix B

### GSD file for C200HW-PRM21

```

;*****
;***
;***      Omron Europe B.V.
;***
;***      European Headquarters
;***      Wegalaan 67-69
;***      NL-2132 JD Hoofddorp
;***      The Netherlands
;***
;***      European Technical Centre
;***      Zilverenberg 2
;***      NL-5234 GM 's-Hertogenbosch
;***      The Netherlands
;***
;*****
;***
;***      Device DataBase File for C200HW-PRM21 PROFIBUS-DP master
;***      Filename          OC_1656.GSD          (c) 1998
;***      Version 1.0      01.10.1998          TM
;***      Version 1.1      20.04.2000          TM
;***
;*****
;
;      Important notice:
;      =====
;      Any modification of parameters in this file may lead to undefined
;      behaviour of the PROFIBUS DP system.
;
;*****
;
#PROFIBUS_DP
GSD_Revision      = 1
Vendor_Name       = "OMRON Corporation"
Model_Name        = "C200HW-PRM21"
Revision          = "V 1.1"
Ident_Number      = 0x1656
Protocol_Ident    = 0                ; PROFIBUS-DP
Station_Type      = 1                ; DP master class 1
FMS_supp         = 0                ; FMS not supported
Hardware_Release  = "V 1.0C"
Software_Release  = "V 1.04"
Bitmap_Device     = "OC1656_R"      ; Bitmap RUNNING
Bitmap_Diag       = "OC1656_D"      ; Bitmap DIAGNOSTIC
Bitmap_SF         = "OC1656_S"      ; Bitmap SPECIAL
;; Supported baudrates
;
9.6_supp          = 1
19.2_supp         = 1
93.75_supp        = 1
187.5_supp        = 1
500_supp          = 1
1.5M_supp         = 1
3M_supp           = 1
6M_supp           = 1
12M_supp          = 1
;
; Maximum station delay of responder
; (unit = bit times)
MaxTsdr_9.6      = 60
MaxTsdr_19.2     = 60
MaxTsdr_93.75    = 60
MaxTsdr_187.5    = 60

```

```

MaxTsdr_500          = 100
MaxTsdr_1.5M        = 150
MaxTsdr_3M          = 250
MaxTsdr_6M          = 450
MaxTsdr_12M         = 800
;
Redundancy           = 0                ; no redundancy
Repeater_Ctrl_Sig    = 2                ; supported, TTL level
24V_Pins             = 0                ; not supported
Implementation_Type  = "ASPC2"
Download_supp        = 0                ; not supported
Upload_supp          = 0                ; not supported
Act_Para_Brct_supp   = 0                ; not supported
Act_Param_supp        = 0                ; not supported
Max_MPS_Length       = 100             ; max.size of master parameter set
Max_Lsdu_MS          = 32              ; max SDU length master-slave
Max_Lsdu_MM          = 32              ; max SDU length master-master
Min_Poll_Timeout     = 1                ; * 10 ms
;
; Time of master to get ready for reply after a sending a request
; (unit = bit times)
Trdy_9.6             = 11
Trdy_19.2            = 11
Trdy_93.75           = 11
Trdy_187.5           = 11
Trdy_500             = 11
Trdy_1.5M            = 11
Trdy_3M              = 11
Trdy_6M              = 11
Trdy_12M             = 11
;
; Quiet time (transmitter fall time)
; (unit = bit times)
Tqui_9.6             = 0
Tqui_19.2            = 0
Tqui_93.75           = 0
Tqui_187.5           = 0
Tqui_500             = 0
Tqui_1.5M            = 0
Tqui_3M              = 3
Tqui_6M              = 6
Tqui_12M             = 9
;
; Setup time
; (unit = bit times)
Tset_9.6             = 1
Tset_19.2            = 1
Tset_93.75           = 1
Tset_187.5           = 1
Tset_500             = 1
Tset_1.5M            = 1
Tset_3M              = 4
Tset_6M              = 8
Tset_12M             = 16
;
; Station delay time of initiator
; (unit = bit times)
Tsd_i_9.6            = 60
Tsd_i_19.2           = 60
Tsd_i_93.75          = 60
Tsd_i_187.5          = 60
Tsd_i_500            = 100
Tsd_i_1.5M           = 150
Tsd_i_3M             = 250
Tsd_i_6M             = 450
Tsd_i_12M            = 800
;
Las_Len              = 125
Max_Slaves_supp      = 124

```

## Appendix C

### CS1 PLC series compatibility

The C200HW-PRM21 can also be installed in OMRON CS1 PLC systems, which provide a C200H-compatible I/O bus. However, the internal memory organisation in the CS1 PLC differs from that of the C200H series. The following table shows the relation between the C200H-series memory addresses used throughout this manual, and the corresponding addresses in the CS1 PLC series.

Function		instead of C200H addresses	CS1 will use addresses
Control & Status area	(MACH No.= 0 to 9)	IR100 ~ IR199	CIO2000 ~ CIO2159
	(MACH No.= A to F)	IR400 ~ IR459	
Unit settings		DM1000 ~ DM2599 or DM7000 ~ DM8599	D20000 ~ D21599
I/O data mapping areas		IR000 ~ IR235	CIO0000 ~ CIO0235
		IR300 ~ IR511	CIO0300 ~ CIO0511
		HR00 ~ HR99	HR000 ~ HR099
		LR00 ~ LR63	CIO1000 ~ CIO1063
		DM0000 ~ DM5999	D00000 ~ D05999
Error flag	(MACH No.= 0 to 9)	AR00.00 ~ AR00.09	AR418.00 ~ AR418.15
	(MACH No.= 0 to F)	IR280.00 ~ IR280.15	
Restart flag	(MACH No.= 0 to 9)	AR01.00 ~ AR01.09	AR502.00 ~ AR502.15
	(MACH No.= 0 to F)	IR281.00 ~ IR281.15	





# Index

## A

Asynchronous ..... See I/O - Data exchange method  
Auto\_clear ..... See Status Bits  
Auto-address ..... 36-37

## B

Baud rate ..... 3, 14, 18, 42  
Broadcast ..... 5, 63  
Bus  
  Cable ..... 14  
  Length ..... 3, 14  
Bus parameters ..... 20, 42  
BUS ..... See Connectors

## C

Cable  
  Configurator ..... 12  
  PROFIBUS ..... 14  
Clear ..... See Master State  
Clear\_Data ..... See Control Commands  
COMM ..... See Indicators  
CONF ..... See Connectors  
Configurator ..... 8, 16, 18, 29-49  
Connectors ..... 15, 18  
  CONF, Configurator ..... 12  
  BUS, PROFIBUS ..... 11  
Control Bits ..... 61  
  I/O communication inhibit ..... 62  
  Input mailbox clear ..... 62, 76  
  Issue control command ..... 62  
  Run ..... 58, 61  
Control command not processed ..... See Status Bits  
Control Commands ..... 62-64  
  Clear\_Data ..... 62, 78  
  Freeze ..... 39, 62, 78  
  Sync ..... 39, 62, 78  
  Unfreeze ..... 62, 78  
  Unsync ..... 62, 78  
Control Words ..... 18, 61  
  Group Select ..... 39, 63  
  Station Address ..... 63  
Cycle Time  
  PLC ..... 24, 97  
  PROFIBUS ..... 20, 57, 65, 97

## D

Default Setting ..... 18, 24, 52-57, 69  
Device Data Base ..... See Files  
Diagnostics ..... 6, 18, 47-49, 69, 79-81  
  Extended ..... 49, 80  
Dimensions ..... 19  
DM setting error ..... See Status Bits  
DM Settings ..... 18, 52-58  
Download ..... 16, 44, 71, 91  
DP-ERR ..... See Indicators

## E

EMC ..... See Installation  
EN 50170 ..... See PROFIBUS  
ERR ..... See Indicators  
Error  
  DM settings ..... 54-56, 66  
  Fatal error handling ..... 58, 61, 71  
  Indicators ..... 70-71, 84  
  Troubleshooting ..... 30, 84-89  
Error number ..... See Status Words

## F

Files  
  Configuration ..... 33  
  Device Data Base ..... 33  
  GSD ..... 8, 33-38, 49, 101  
Flags  
  Slave Active ..... 57, 69  
  Slave Diagnostic ..... 57, 69  
Freeze ..... See Control Commands

## G

Grounding ..... See Installation  
Group Select ..... See Control Words  
Group Membership ..... 39  
GSD ..... See Files

## H

Humidity ..... See Installation

## I

I/O  
  Data areas ..... 18, 52-56, 66  
  Data exchange method ..... 18, 57, 97  
    Asynchronous ..... 18, 25, 57, 97  
    Synchronous ..... 18, 27, 57, 97  
  Mapping ..... 36-41, 51-56  
  Refresh ..... 24, 97  
  Response Time ..... 25-28, 57, 97  
I/O communication inhibit ..... See Control Bits  
Indicators, LEDs ..... 18, 70  
  COMM ..... 71, 86-87  
  DP-ERR ..... 44, 65, 71, 84-87  
  ERR ..... 53, 55-56, 66, 70, 84-89  
  NW-ST ..... 67, 71  
  READY ..... 44, 71, 85-86  
  RUN ..... 44, 70, 85, 95  
Input data transferred ..... See Status Bits  
Input mailbox clear ..... See Control Bits  
Inputs  
  Areas ..... 52-56, 65, 95-97  
  Freeze ..... 39, 62-64, 78, 81

---

## Index

---

- Installation  
  EMC ..... xiv, 18  
  Grounding..... xiii, 11, 15  
  Humidity..... xii, 18, 90  
  Temperature ..... xii, 18, 90
- Instructions  
  IORD ..... 18, 59, 76-77, 89  
  IORF..... 25, 27, 52  
  IOWR ..... 18, 59, 74-75, 89
- Issue control command..... See Control Bits
- L**
- LEDs ..... See Indicators
- M**
- Machine No. .... See Switches
- Mailbox..... 59, 62, 67-69
- Maintenance..... 90
- Mapping ..... See I/O
- Master State  
  Clear..... 7, 44, 47, 67, 71  
  Offline..... 7, 47, 67, 71  
  Operate..... 7, 42, 47, 67, 71, 98  
  Stop ..... 7, 47, 62, 67, 71
- Message Length ..... See Status Words
- Multicast..... 5, 63
- N**
- Network state ..... See Status Bits
- No\_data ..... See Status Bits
- NW-ST ..... See Indicators
- O**
- Offline..... See Master State
- Operate ..... See Master State
- Output mailbox full ..... See Status Bits
- Outputs  
  Areas..... 52-56, 65, 95-97  
  Sync ..... 39, 62-64, 78, 81
- P**
- P-DP H/W failure..... See Status Bits
- PLC  
  CPU types ..... 11, 18, 24, 52-55, 60, 84, 97  
  PROGRAM mode..... 58, 88, 95  
  Programming tips ..... 93
- Precautions ..... xi-xiv, 91
- PROFIBUS  
  FMS..... 2  
  PA..... 2  
  Standard EN 50170 ..... 2, 11, 14, 20, 48, 81
- R**
- READY ..... See Indicators
- Repeater ..... 14
- Reply in input mailbox..... See Status Bits
- Response time ..... 25-28
- Run ..... See Control Bits
- RUN..... See Indicators
- S**
- Slave Active..... See Flags
- Slave Diagnostic ..... See Flags
- Specifications  
  Bus cable..... 14  
  Configurator..... 29  
  Master Unit ..... 18
- Station Address ..... See Control/Status Words
- Stations  
  Active, Passive..... 4  
  Replacing..... 91
- Status Bits  
  Auto\_clear ..... 6-7, 44, 65  
  Control command not processed ..... 67  
  DM setting error ..... 66  
  Input data transferred ..... 65  
  Network state ..... 67  
  No\_data ..... 65  
  Output mailbox full..... 67, 75, 89  
  P-DP H/W failure ..... 66  
  Reply in input mailbox..... 67, 76, 80, 89  
  Wrong CPU Unit..... 66
- Status Words..... 18, 64  
  Error number ..... 68  
  Message Length ..... 68, 76  
  Station address..... 65, 68  
  Unit Number ..... 68, 76
- Stop ..... See Master State
- Switches..... 18  
  Machine No. .... 10-11, 13, 52, 60  
  TERM, Termination ..... 13
- Sync ..... See Control Commands
- Synchronous ..... See I/O - Data exchange method
- T**
- Temperature..... See Installation
- TERM ..... See Switches
- Termination..... 13
- Time  
  Bus Cycle..... 20, 57, 65, 97  
  I/O response..... 25-28  
  I/O refresh..... 24, 97
- Tips, PLC programming..... 93
- Troubleshooting ..... See Error
- U**
- Unfreeze..... See Control Commands
- Unit Number ..... See Status Words
- Unit Settings ..... 18, 52-58
- Unsync ..... See Control Commands
- W**
- Watchdog..... 6, 36, 44, 57
- Wrong CPU Unit..... See Status Bits

## Revision History

A manual revision code appears as a suffix to the catalog number on the front cover of the manual.

Cat. No. W349-E2-2  
↑  
Revision code

The following table outlines the changes made to the manual during each revision. Page numbers refer to the previous version.

Revision code	Date	Revised content
E1-1	September 1998	Original production
E2-2	May 2000	Added drawing of cable shield connection (2-3-1) Adapted Chapter 4 to new version of PROFIBUS-DP Configurator SyCon V2.x Added references to CS1-series PLC's, including Appendix C



**Regional Headquarters**

**OMRON EUROPE B.V.**

Wegalaan 67-69, NL-2132 JD Hoofddorp

The Netherlands

Tel: (31) 2356-81-300

Fax: (31) 2356-81-388

# OMRON

**Authorised Distributor:**