

## Output Block

G70D-VSOC16/  
VFOM16

### Easy-to-use, Space-saving, 16-point Output Block

- Terminal block is as slim as 135 x 40 mm (W x D).
- Independent contacts and short bars ensure easy common connections.
- Allows the mounting of an Expansion Terminal Block for power line connections.
- M3.5 fork-type crimp terminals (with a maximum terminal width of 6.2 mm) can be used.
- Lever mechanism easily removes Relays with no tools.
- Relay models and power MOS FET Relay models are available.
- Incorporates operation indicators.
- Built-in diode absorbs coil surge.
- Mount either to DIN track or via screws.



## Ordering Information

### Model Number Legend

G70D-□□□  
1 2 3

#### 1. Shape

V: Vertical type

#### 2. Mounted Relay Type

SOC: Relay

FOM: Power MOS FET Relay

#### 3. Output Points

16: 16-point

Classification	Points	Internal output circuit common	Rated voltage	Model
Relay outputs	16 points (SPST-NO x 16)	NPN (+common)	24 VDC	G70D-VSOC16
Power MOS FET Relay outputs				G70D-VFOM16

### Accessories

#### Replacement Relays

Applicable Output Block	Rated voltage	Model
G70D-VSOC16	24 VDC	G6D-1A (see note)
	24 VDC	G6D-1A-AP (see note)
G70D-VFOM16	24 VDC	G3DZ-2R6PL

**Note:** Error rate (level p) of G6D-1A (reference value): 10 mA at 5 VDC  
Error rate (level p) of G6D-1A-AP (reference value): 1 mA at 5 VDC

#### Short Bar

Applicable Terminal Relay	Model
G70D-VSOC16	G6D-4-SB
G70D-VFOM16	

#### Expansion Terminal Block

Applicable Terminal Relay	Model
G70D-VSOC16	G70D-ET
G70D-VFOM16	

#### Connector Cable for Output Block

Cable Type	Model
Cable with Loose Wire and Crimp Terminals	G79-Y□C
Cable with Loose Wires	G79-A□C
Cable with Connector (1:3)	G79-□C-□-□
Cable with Connector (1:2)	G79-O□C-□
Cable with Connector (1:1)	G79-□C

# Specifications

## ■ Ratings

**Note:** The following values apply to the G6D Relay mounted to the G70D and do not apply to the G6D Relay itself before it is mounted.

### Coil Ratings (per G6D Relay)

Rated voltage	24 VDC
Rated current	10.5 mA
Coil resistance	2,880 $\Omega$
Must operate voltage	70% max. of rated voltage
Release voltage	10% min. of rated voltage
Max. allowable voltage	130% of rated voltage
Power consumption	Approx. 200 mW

- Note:**
1. The must operate voltage is 75% max. of the rated voltage if the Relay is mounted upside down.
  2. Rated current and coil resistance were measured at a coil temperature of 23°C with a tolerance of  $\pm 10\%$ .
  3. Operating characteristics were measured at a coil temperature of 23°C.
  4. The maximum allowable voltage is the maximum value of the allowable voltage range for the relay coil operating power supply. There is no continuous allowance.
  5. The rated current includes the current consumption of the operation indicator.

### Contact Ratings (per G6D Relay)

Load	Resistive load ( $\cos\phi = 1$ )
Rated load	3 A at 250 VAC, 3 A at 30 VDC
Rated carry current	5 A (see note 1)
Max. switching voltage	250 VAC, 30 VDC
Max. switching current	5 A
Max. switching capacity	1,250 VA, 150 W
Error rate (level p) (reference value) (see note 2)	5 VDC, 1 mA
Life expectancy	Electrical: 100,000 operations min. (under and at the rated load at 1,800 operations/hr) Mechanical: 20,000,000 operations min. (at 18,000 operations/hr)

- Note:**
1. This value is for when the maximum 8 points are ON.
  2. This value is for a switching frequency of 120 times per minute.

## Power MOS FET Relay Specifications

**Note:** The following values apply to the G3DZ Relay mounted to the G70D and do not apply to the G3DZ Relay itself before it is mounted.

### Input (per G3DZ Power MOS FET Relay)

Rated voltage	24 VDC	
Operating voltage	19.2 to 28.8 VDC	
Voltage level	Must operate	19.2 VDC max.
	Must release	1 VDC min.
Input impedance	4 k $\Omega$ $\pm 20\%$	
Rated current	8.2 mA $\pm 20\%$	

**Note:** The rated current includes the current consumption of the operation indicator.

### Output (per G3DZ Power MOS FET Relay)

Load voltage	3 to 264 VAC, 3 to 125 VDC
Load current	100 $\mu$ A to 0.3 A
Inrush current	6 A (10 ms)

## ■ Characteristics

Item	G70D-VSOC16	G70D-VFOM16
	Relay outputs	Power MOS FET Relay outputs
Contact form	16 points (SPST-NO x 16)	
Contact mechanism	Single	---
Contact resistance	100 mΩ max. (see note 2)	---
Insulation method	---	Photocoupler
Must operate time	10 ms max. (see note 3)	6 ms max.
Release time	10 ms max. (see note 3)	10 ms max.
Output ON-resistance	---	2.4 Ω max.
Leakage current at OFF state	---	10 μA max. (at 125 VDC)
Max. switching frequency	Mechanical: 18,000 operations/hr Rated load: 1,800 operations/hr	---
Insulation resistance	100 MΩ min. (at 500 VDC)	
Dielectric strength	2,000 VAC for 1 min between coil and contact	2,000 VAC for 1 min between input and output terminals
Noise immunity	Power input (normal mode): 600 V for 10 min with a pulse width of 100 ns/1 μs Power input (common mode): 1.5 kV for 10 min with a pulse width of 100 ns/1 μs Input cable (coiling): 1.5 kV for 10 min with a pulse width of 100 ns/1 μs Unit body (coiling): 600 V for 10 min with a pulse width of 100 ns/1 μs	
Vibration resistance	Destruction: 10 to 55 Hz, 1.0-mm double amplitude for 2 hrs each in X, Y, and Z directions Malfunction: 10 to 55 Hz, 0.75-mm double amplitude for 2 hrs each in X, Y, and Z directions	
Shock resistance	Destruction: 300 m/s <sup>2</sup> Malfunction: 100 m/s <sup>2</sup>	
Operating voltage range	24 VDC +10%/-15%	
Current consumption	Approx. 170 mA at 24 VDC (see note 4)	Approx. 125 mA at 24 VDC (see note 5)
Cable length	Between block and controller: 5 m max. (reference value for AWG28) Between block and external device: Dependent on load	
LED color	Operation indicator: orange	
Coil surge absorber	Diode (600 V, 1 A)	
Ambient temperature	Operating: -25°C to 55°C (with no icing or condensation) Storage: -25°C to 65°C (with no icing or condensation)	
Ambient humidity	Operating: 45% to 85%	
Mounting strength	No damage when 49 N pull load was applied for 1 s in all directions (except for 9.8 N min. in direction of rail)	
Terminal strength	Tightening torque: 0.78 to 1.18 N • m Pull strength: 49 N for 1 min	
Weight (see note 6)	Approx. 280 g	

- Note:**
1. The above values are initial values.
  2. Measurement condition: 1 A at 5 VDC
  3. Ambient temperature: 23°C
  4. Current consumption is when all points are ON and includes G6D Relay coil current but does not include any external load current.
  5. Current consumption is when all points are ON and includes G3DZ input current but does not include any external load current.
  6. The Unit weighs approximately 315 g with the Expansion Terminal Block mounted.

# Engineering Data

## G70D-VSOC16

### Max. Switching Capacity

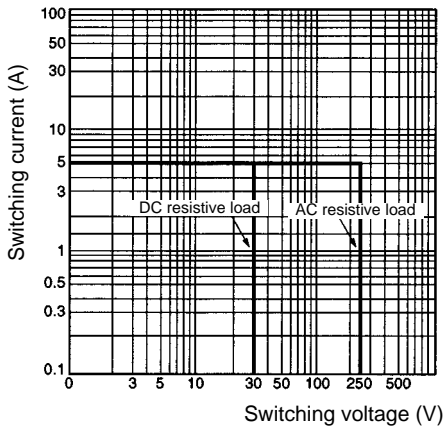

### Life Expectancy

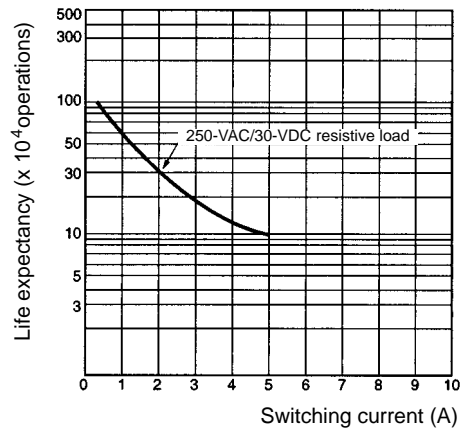

## G70D-VFOM16

### Load Current vs. Ambient Temperature Characteristics

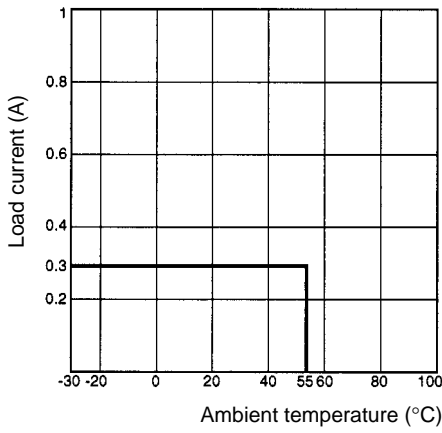

### Inrush Current Resistivity

Non-repetitive (Keep the inrush current to half the rated value or less if it occurs repeatedly.)

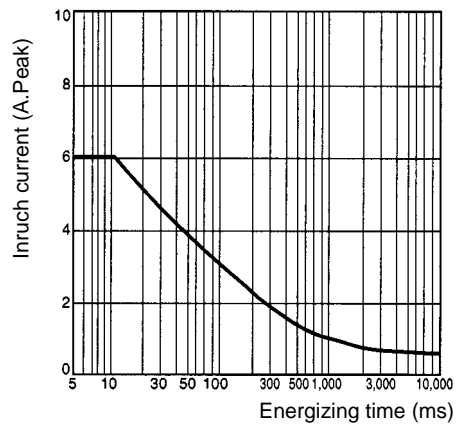

# Operation

## Internal Circuit

### G70D-VSOC16/G70D-VFOM16

NPN-compatible output terminal (+ common output): A controller with an NPN transistor (– common output) can be connected.

#### Connector Terminal Arrangement (Top View)

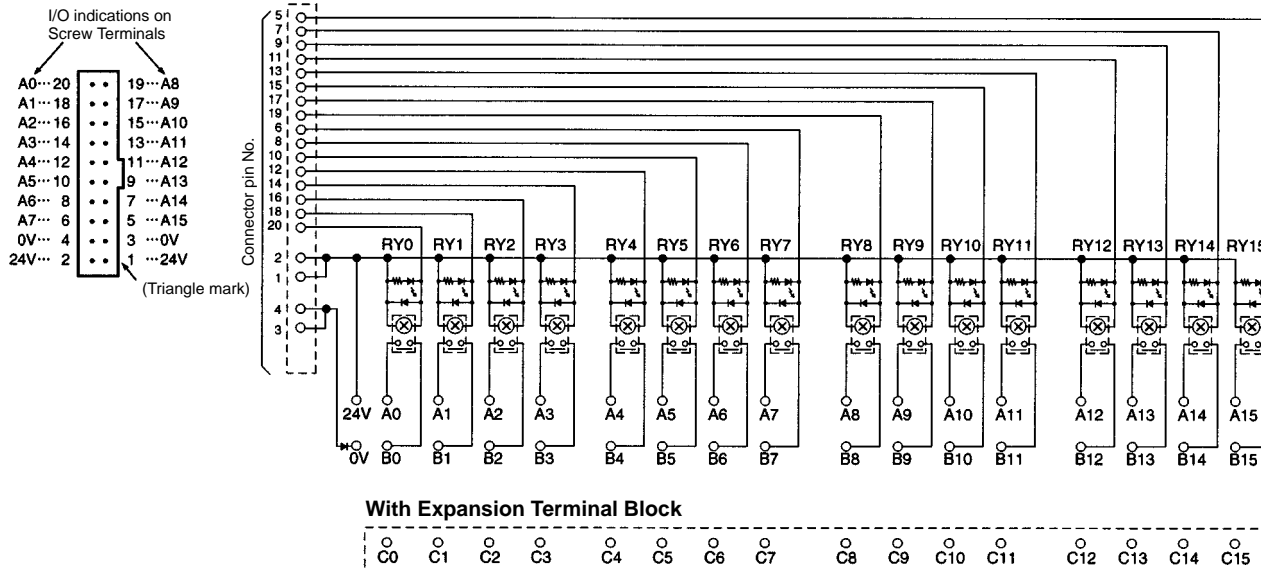

- Note:**
1. The above terminal block is for the G70D-VSOC16, which operates with G6D Relays mounted. If the model is the G70D-VFOM16, G3DZ Power MOS FET Relays are mounted in place of G6D Relays.
  2. Terminals C0 to C15 are electrically independent from each other.
  3. When the terminal block and relay block are connected to each other, each electrical check terminal of the relay block is connected to the corresponding terminal of the terminal block.

■ Terminal Arrangement and Load Connection Examples

Without Expansion Terminal Block

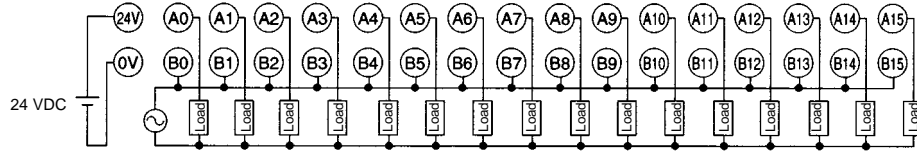
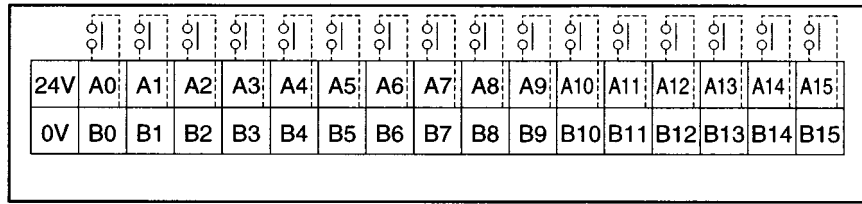

With Expansion Terminal Block

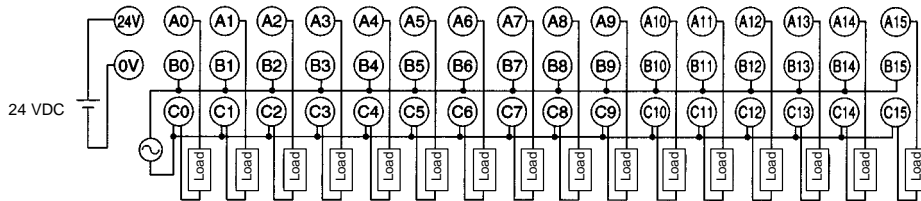
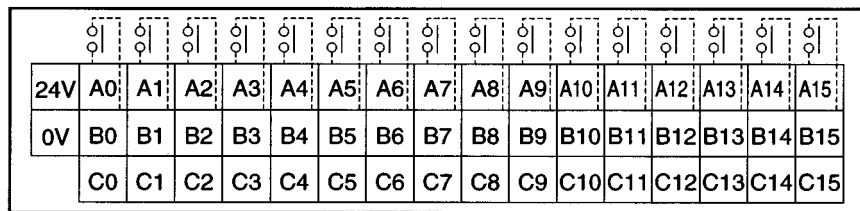

Electrical check terminals (see note)

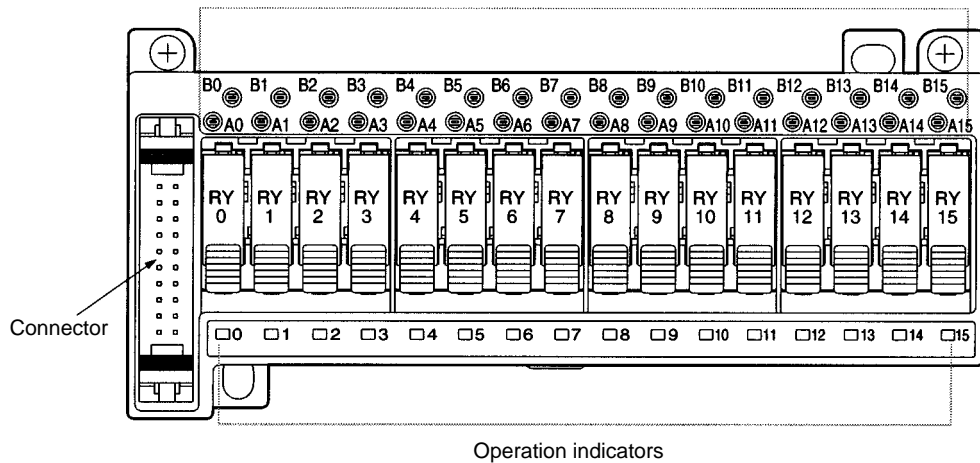

**Note:** When the terminal block and relay block are connected to each other, each electrical check terminal of the relay block is connected to the corresponding terminal of the terminal block.

# Dimensions

**Note:** All units are in millimeters unless otherwise indicated.

## G70D-VSOC16 G70D-VFOM16

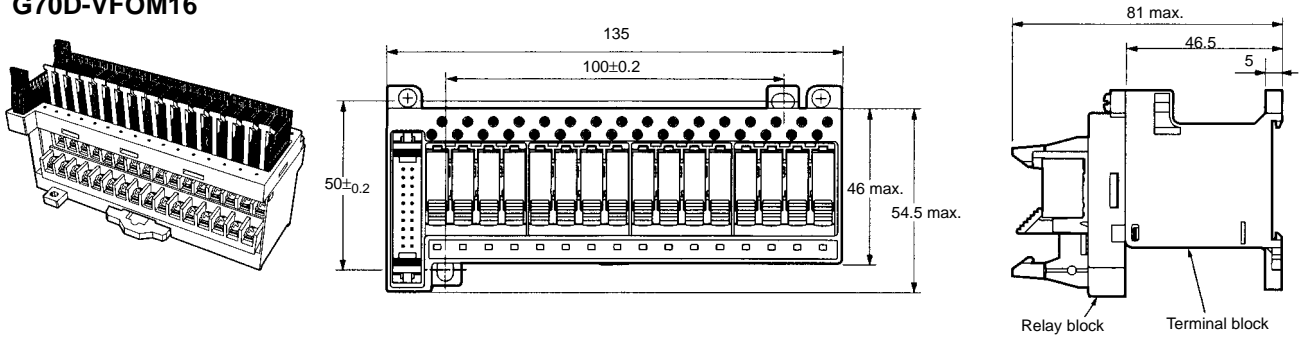

### Terminal Block (without Expansion Terminal Block)

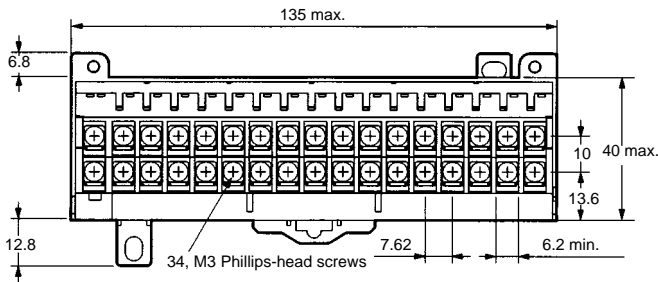

### Terminal Block (with Expansion Terminal Block)

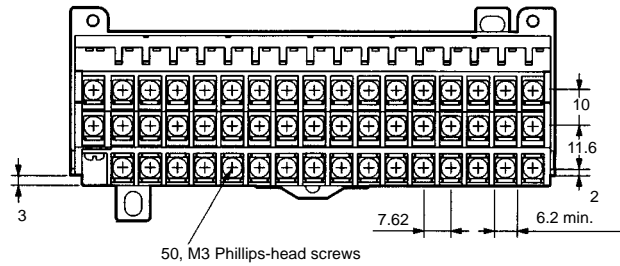

### Mounting Holes

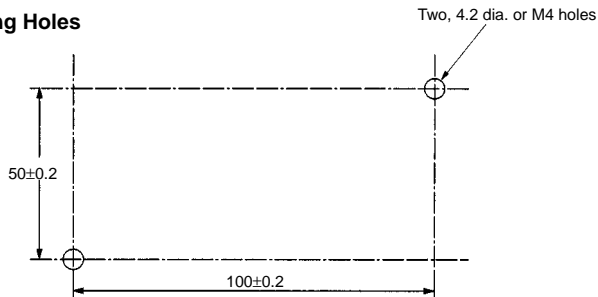

■ Accessories (Sold Separately)

Connector Cable for Output Blocks

With loose wires and crimp terminals		With loose wires	
Length (ℓ)	Model	Length (ℓ)	Model
1,000 mm	G79-Y100C	2,000 mm	G79-A200C
1,500 mm	G79-Y150C	5,000 mm	G79-A500C
2,000 mm	G79-Y200C		
3,000 mm	G79-Y300C		
5,000 mm	G79-Y500C		

G79-Y□C Cable with Loose Wires and Crimp Terminals

Convenient for connecting screw terminals to Output Blocks

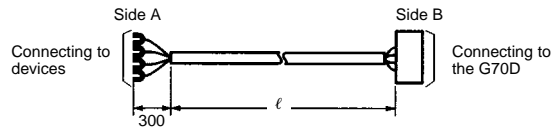
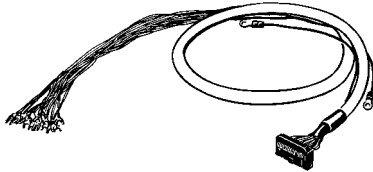

G79-A□C Cable with Loose Wires

Device connection end provides loose wires.

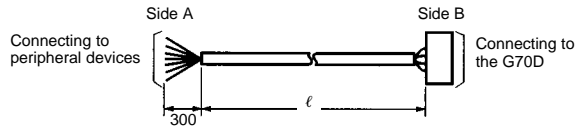
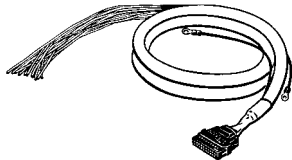

G79-□C-□-□ Cable with Connector (1:3)

Connectable I/O Unit of OMRON Programmable Controller		Connector Cable for Output Blocks (See Note 2)			
Model	No. of output points	Length (ℓ)			Model
		A	B	C	
CS1W-OD291	96	1,500 mm	1,250 mm	1,000 mm	G79-150C-125-100
CS1W-MD291	48	2,000 mm	1,750 mm	1,500 mm	G79-200C-175-150
		3,000 mm	2,750 mm	2,500 mm	G79-300C-275-250

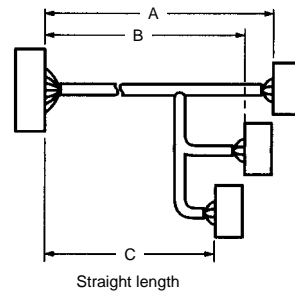
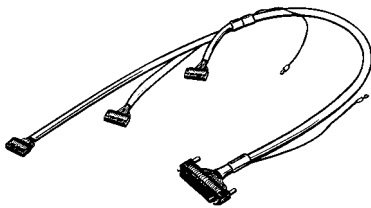



**G79-O□C-□ Cable with Connector (1:2)**

Connectable I/O Unit of OMRON Programmable Controller		Connector Cable for Output Blocks (See Note 2)		
Model	No. of output points	Length (ℓ)		Model
		A	B	
C200H-OD218	32	1,000 mm	750 mm	G79-O100C-75
C200H-OD219	64	1,500 mm	1,250 mm	G79-O150C-125
C500-OD213	64	2,000 mm	1,750 mm	G79-O200C-175
CQM1-OD213	32	3,000 mm	2,750 mm	G79-O300C-275
		5,000 mm	4,750 mm	G79-O500C-475

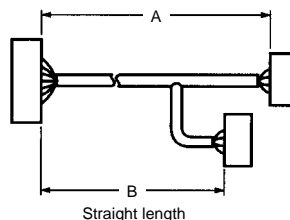
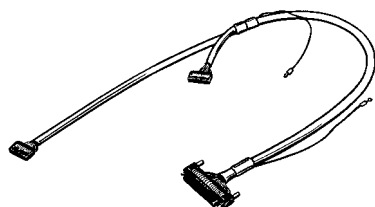

**G79-□C Cable with Connector (1:1)**

Connectable I/O Unit of OMRON Programmable Controller		Connector Cable for Output Blocks (See Note 2)	
Model	No. of output points	Length (ℓ)	Model
C200H-OD215	32	1,000 mm	G79-100C
C500-OD415CN	32	1,500 mm	G79-150C
C500-MD211CN	16	2,000 mm	G79-200C
		3,000 mm	G79-300C
		5,000 mm	G79-500C

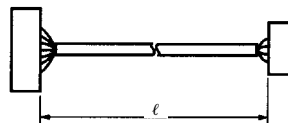
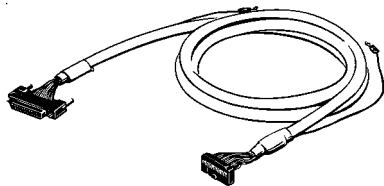

- Note:**
1. The number of I/O points used must correspond to the number of Output Blocks.
  2. The number of I/O connectors used must correspond to the number of cables.

**G70D-ET Expansion Terminal Block**

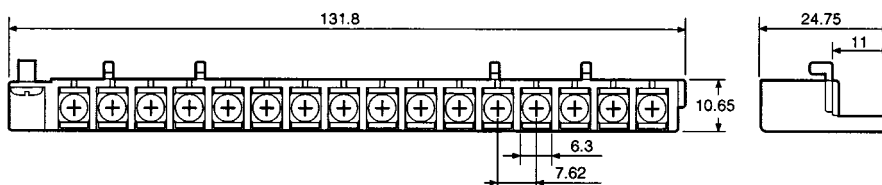
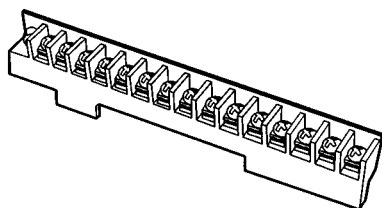

**G6D-4-SB Short Bar**

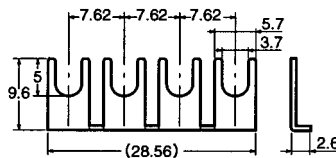
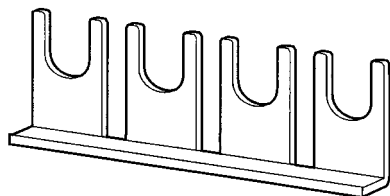

# Precautions

## ■ General Precautions

### Electric Shock

Do not touch the terminal block (i.e., charged parts) of Relays or Sockets while power is being supplied to the Output Block. Otherwise, an electric shock may result.

### Wiring

Be sure to turn OFF the power when wiring the Output Block and do not touch the charged terminals of the Output Block. Otherwise, an electric shock may result. Turn ON the power after the Output Block is wired and the relay block is mounted.

Apply specified voltages to the input terminals. Otherwise, the Output Block may malfunction, receive damage, or burn.

### Relay Models

Do not connect the Output Block to any load exceeding the rated switching voltage or current of the Output Block. Otherwise, faulty insulation, contact weld, or faulty contact of the Relays, damage to the Relays may result or the Relays may malfunction or burn.

The life of a Relay varies with the switching condition. Test the Relays under the actual operating conditions before using the Relays within the permissible switching frequency. The use of deteriorated Relays may result in the faulty insulation of the Relays or cause the Relays to burn.

Do not use the Output Block in places with flammable gas. Otherwise, a fire or explosion due to the heat of the Relays or a spark from the Relays may result when they are switched.

### Power MOS FET Models

Do not connect the Output Block to loads consuming a total current exceeding the rated output current of the Output Block. Otherwise, damage to the output element and a short or open-circuit malfunction may result.

If the Output Block is connected to a DC inductive load, connect a diode to the Output Block to protect the Output Block from counter-electromotive voltage. Otherwise, damage to the output element and a short or open-circuit malfunction may result.

## ■ Correct Use

### Replacing Relays

Turn OFF the Output Block to replace Relays. Otherwise, an electric shock may result or the Output Block may malfunction.

When mounting a Relay, press the upper part of the Relay straight down until the Relay is locked with the hooks while making sure that none of the Relay terminals are bent. Otherwise, the Output Block may malfunction or radiate heat.

### Wiring

Make sure that the polarity of each terminal is correct, the power lines are wired properly, and the terminal voltage is appropriate.

Do not disconnect or connect the connector while the Output Block is turned ON. Otherwise, the Output Block may malfunction.

### Cable Connector Locks

Before the Output Block is turned ON, make sure that the connectors of all the cables connected to the Output Block are locked.

### Installation Environment

Do not install the Output Block in the following locations. Otherwise, damage to the Output Block may result or the Output Block may malfunction.

- Locations with direct sunlight.
- Locations with ambient temperature ranges not within  $-25^{\circ}\text{C}$  to  $55^{\circ}\text{C}$ .
- Locations with rapid temperature changes resulting in condensation or relative humidity ranges not within 45% to 85%.
- Locations with corrosive or inflammable gas.
- Locations with excessive dust, salinity, or metal powder.
- Locations with vibration or shock affecting the Output Block.

- Locations with water, oil, or chemical sprayed on the Output Block.

### Screw Tightening Torque

Tighten all screws of the Output Block properly. Otherwise, the Output Block may malfunction.

- Terminal screws: Tighten each terminal screw to a torque of 0.78 to 1.18 N • m.
- Mounting screws: Tighten each mounting screw to a torque of 0.59 to 0.98 N • m
- Relay block mounting screws: Tighten each mounting screw to a torque of 0.59 to 0.98 N • m.

### Cleaning

Do not use paint thinner to clean the surface. Otherwise, surface damage or discoloration may result.

### Handling

Do not drop the Output Block or shock or vibrate the Output Block excessively. Otherwise, damage to the Output Block may result or the Output Block may malfunction.

### Disassembling, Repairing, and Modifying

Do not disassemble, repair, or modify the Output Block. Otherwise, an electric shock may result or the Output Block may malfunction.

### Output Block Configuration

For ease-of-use and space-saving, the G70D-VSOC16 incorporates a terminal block and relay block that can be separated from the Output Block. The relay block has operation indicators and replaceable Relays along with electrical check terminals for monitoring the operation of the Output Block.

The Expansion Terminal Block can be mounted to the Output Block for power line connections.

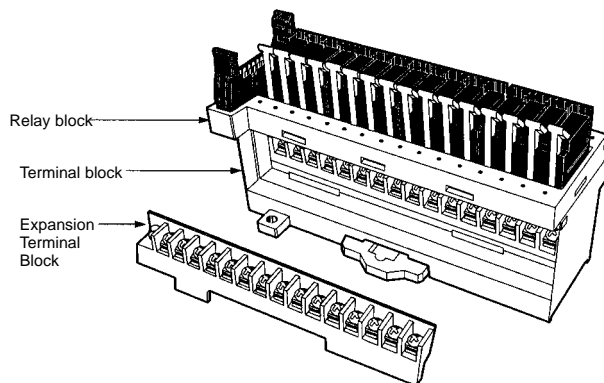

### Removing and Mounting the Terminal Block and Relay Block

#### 1. Removing

Check that the load and the Output Block are both turned OFF.

Turn the mounting screws of the relay block counterclockwise alternately and equally until the relay block is slightly raised.

When the relay block is slightly raised, disconnect the protruding part A of the relay block from the interior wall of the Output Block.

Further turn the mounting screws counterclockwise and remove the mounting screws. Then remove the relay block.

#### 2. Mounting

Check that the load and the Output Block are both turned OFF.

Check that the part B of the terminal block is free of metal dust or other foreign materials.

Mount the relay block straight along the groove of the terminal block.

Press the both ends of the relay block and place the protruding part A onto the interior wall of the Output Block.

Tighten the mounting screws of the relay block clockwise alternately and equally to secure the relay block

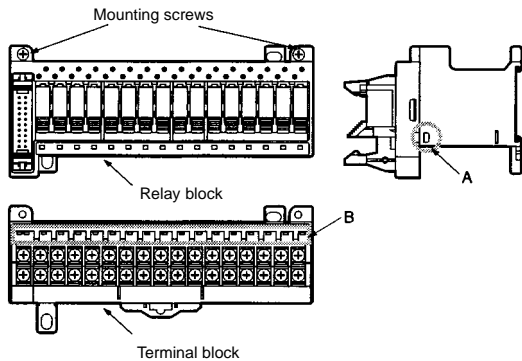

### Nameplate of Terminal Block

As shown in Figure 1, the nameplate of the terminal block is located on the bottom surface of the relay block.

To fill in the nameplate, remove the nameplate from the relay block. Then return it to the original location when finished.

To read the nameplate after the Output Block is mounted to a panel, for example, pull out the nameplate from the bottom surface of the relay block as shown in Figure 2.

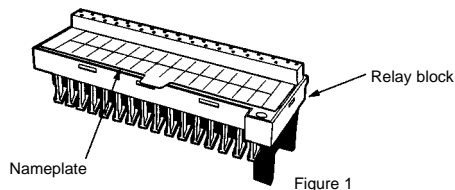

Figure 1

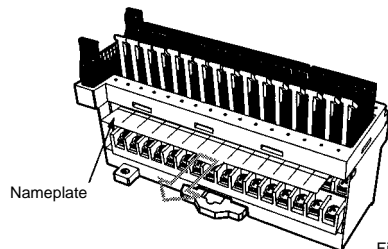
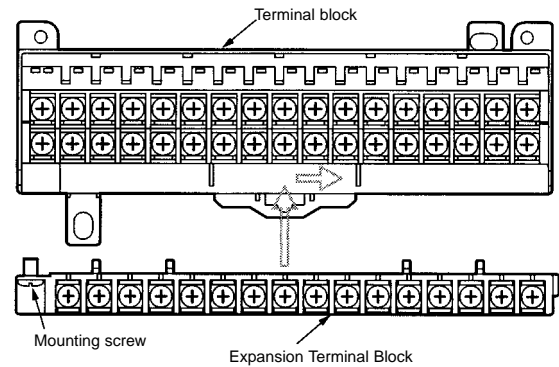

Figure 2

### Mounting the Expansion Terminal Block

Insert the hooks of the Expansion Terminal Block into the mounting holes on the terminal block and slide the Expansion Terminal Block so that it will not separate from the terminal block.

Tighten the mounting screw of the Expansion Terminal Block securely.



### Electrical Check Terminals

The terminal block of the G70D-VSOC16 in operation is located under the relay block. Therefore, unlike the terminal blocks of other models, electrical checks on the terminals are not possible with multimeter probes. The relay block of the G70D-VSOC16, however, incorporates electrical check terminals, each of which is connected to the corresponding terminal of the terminal block. All the pairs of these terminals share single terminal numbers respectively.

To check these terminals, apply multimeter probes to these terminals.

Do not touch these energized terminals with a thin metal object or similar objects. Doing so may result in an electric shock.

